

# 1N5820, 1N5821, 1N5822

1N5820 and 1N5822 are Preferred Devices

## Axial Lead Rectifiers

...employing the Schottky Barrier principle in a large area metal-to-silicon power diode. State-of-the-art geometry features chrome barrier metal, epitaxial construction with oxide passivation and metal overlap contact. Ideally suited for use as rectifiers in low-voltage, high-frequency inverters, free wheeling diodes, and polarity protection diodes.

- Extremely Low  $V_F$
- Low Power Loss/High Efficiency
- Low Stored Charge, Majority Carrier Conduction

### Mechanical Characteristics:

- Case: Epoxy, Molded
- Weight: 1.1 gram (approximately)
- Finish: All External Surfaces Corrosion Resistant and Terminal Leads are Readily Solderable
- Lead and Mounting Surface Temperature for Soldering Purposes: 220°C Max. for 10 Seconds, 1/16" from case
- Shipped in plastic bags, 500 per bag
- Available Tape and Reeled, 1500 per reel, by adding a "RL" suffix to the part number
- Polarity: Cathode indicated by Polarity Band
- Marking: 1N5820, 1N5821, 1N5822

### MAXIMUM RATINGS

Please See the Table on the Following Page



**ON Semiconductor®**

<http://onsemi.com>

**SCHOTTKY BARRIER  
RECTIFIERS  
3.0 AMPERES  
20, 30, 40 VOLTS**

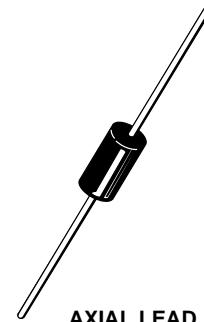

**AXIAL LEAD  
CASE 267-05  
(DO-201AD)  
STYLE 1**

### MARKING DIAGRAM

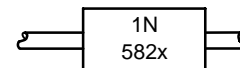

1N582x = Device Code  
x = 0, 1 or 2

### ORDERING INFORMATION

Device	Package	Shipping
1N5820	Axial Lead	500 Units/Bag
1N5820RL	Axial Lead	1500/Tape & Reel
1N5821	Axial Lead	500 Units/Bag
1N5821RL	Axial Lead	1500/Tape & Reel
1N5822	Axial Lead	500 Units/Bag
1N5822RL	Axial Lead	1500/Tape & Reel

**Preferred** devices are recommended choices for future use and best overall value.

# 1N5820, 1N5821, 1N5822

## MAXIMUM RATINGS

Rating	Symbol	1N5820	1N5821	1N5822	Unit
Peak Repetitive Reverse Voltage Working Peak Reverse Voltage DC Blocking Voltage	$V_{RRM}$ $V_{RWM}$ $V_R$	20	30	40	V
Non-Repetitive Peak Reverse Voltage	$V_{RSM}$	24	36	48	V
RMS Reverse Voltage	$V_{R(RMS)}$	14	21	28	V
Average Rectified Forward Current (Note 1) $V_{R(equiv)} \leq 0.2 V_{R(dc)}$ , $T_L = 95^\circ\text{C}$ ( $R_{\theta JA} = 28^\circ\text{C/W}$ , P.C. Board Mounting, see Note 5)	$I_O$	← 3.0 →			A
Ambient Temperature Rated $V_{R(dc)}$ , $P_{F(AV)} = 0$ $R_{\theta JA} = 28^\circ\text{C/W}$	$T_A$	90	85	80	$^\circ\text{C}$
Non-Repetitive Peak Surge Current (Surge applied at rated load conditions, half wave, single phase 60 Hz, $T_L = 75^\circ\text{C}$ )	$I_{FSM}$	← 80 (for one cycle) →			A
Operating and Storage Junction Temperature Range (Reverse Voltage applied)	$T_J, T_{stg}$	← -65 to +125 →			$^\circ\text{C}$
Peak Operating Junction Temperature (Forward Current applied)	$T_{J(pk)}$	← 150 →			$^\circ\text{C}$

### \*THERMAL CHARACTERISTICS (Note 5)

Characteristic	Symbol	Max	Unit
Thermal Resistance, Junction to Ambient	$R_{\theta JA}$	28	$^\circ\text{C/W}$

### \*ELECTRICAL CHARACTERISTICS ( $T_L = 25^\circ\text{C}$ unless otherwise noted) (Note 1)

Characteristic	Symbol	1N5820	1N5821	1N5822	Unit
Maximum Instantaneous Forward Voltage (Note 2) ( $i_F = 1.0$ Amp) ( $i_F = 3.0$ Amp) ( $i_F = 9.4$ Amp)	$V_F$	0.370 0.475 0.850	0.380 0.500 0.900	0.390 0.525 0.950	V
Maximum Instantaneous Reverse Current @ Rated dc Voltage (Note 2) $T_L = 25^\circ\text{C}$ $T_L = 100^\circ\text{C}$	$i_R$	2.0 20	2.0 20	2.0 20	mA

1. Lead Temperature reference is cathode lead 1/32" from case.

2. Pulse Test: Pulse Width = 300  $\mu\text{s}$ , Duty Cycle = 2.0%.

\*Indicates JEDEC Registered Data for 1N5820-22.

**NOTE 3 — DETERMINING MAXIMUM RATINGS**

Reverse power dissipation and the possibility of thermal runaway must be considered when operating this rectifier at reverse voltages above 0.1  $V_{RWM}$ . Proper derating may be accomplished by use of equation (1).

$$T_{A(max)} = T_{J(max)} - R_{\theta JA} P_{F(AV)} - R_{\theta JA} P_{R(AV)} \quad (1)$$

where  $T_{A(max)}$  = Maximum allowable ambient temperature

$T_{J(max)}$  = Maximum allowable junction temperature (125°C or the temperature at which thermal runaway occurs, whichever is lowest)

$P_{F(AV)}$  = Average forward power dissipation

$P_{R(AV)}$  = Average reverse power dissipation

$R_{\theta JA}$  = Junction-to-ambient thermal resistance

Figures 1, 2, and 3 permit easier use of equation (1) by taking reverse power dissipation and thermal runaway into consideration. The figures solve for a reference temperature as determined by equation (2).

$$T_R = T_{J(max)} - R_{\theta JA} P_{R(AV)} \quad (2)$$

Substituting equation (2) into equation (1) yields:

$$T_{A(max)} = T_R - R_{\theta JA} P_{F(AV)} \quad (3)$$

Inspection of equations (2) and (3) reveals that  $T_R$  is the ambient temperature at which thermal runaway occurs or where  $T_J = 125^\circ\text{C}$ , when forward power is zero. The transition from one boundary condition to the other is evident on the curves of Figures 1, 2, and 3 as a difference in the rate of change of the slope in the vicinity of 115°C. The data of Figures 1, 2, and 3 is based upon dc conditions. For

use in common rectifier circuits, Table 1 indicates suggested factors for an equivalent dc voltage to use for conservative design, that is:

$$V_{R(equiv)} = V_{(FM)} \times F \quad (4)$$

The factor F is derived by considering the properties of the various rectifier circuits and the reverse characteristics of Schottky diodes.

EXAMPLE: Find  $T_{A(max)}$  for 1N5821 operated in a 12-volt dc supply using a bridge circuit with capacitive filter such that  $I_{DC} = 2.0\text{ A}$  ( $I_{F(AV)} = 1.0\text{ A}$ ),  $I_{(FM)}/I_{(AV)} = 10$ , Input Voltage = 10  $V_{(rms)}$ ,  $R_{\theta JA} = 40^\circ\text{C/W}$ .

Step 1. Find  $V_{R(equiv)}$ . Read  $F = 0.65$  from Table 1,

$$\therefore V_{R(equiv)} = (1.41)(10)(0.65) = 9.2\text{ V.}$$

Step 2. Find  $T_R$  from Figure 2. Read  $T_R = 108^\circ\text{C}$

$$@ V_R = 9.2\text{ V and } R_{\theta JA} = 40^\circ\text{C/W.}$$

Step 3. Find  $P_{F(AV)}$  from Figure 6. \*\*Read  $P_{F(AV)} = 0.85\text{ W}$

$$@ \frac{I_{(FM)}}{I_{(AV)}} = 10 \text{ and } I_{F(AV)} = 1.0\text{ A.}$$

Step 4. Find  $T_{A(max)}$  from equation (3).

$$T_{A(max)} = 108 - (0.85)(40) = 74^\circ\text{C.}$$

\*\*Values given are for the 1N5821. Power is slightly lower for the 1N5820 because of its lower forward voltage, and higher for the 1N5822. Variations will be similar for the MBR-prefix devices, using  $P_{F(AV)}$  from Figure 6.

**Table 1. Values for Factor F**

Circuit	Half Wave		Full Wave, Bridge		Full Wave, Center Tapped*†	
	Resistive	Capacitive*	Resistive	Capacitive	Resistive	Capacitive
Sine Wave	0.5	1.3	0.5	0.65	1.0	1.3
Square Wave	0.75	1.5	0.75	0.75	1.5	1.5

\*Note that  $V_{R(PK)} \approx 2.0 V_{in(PK)}$ . †Use line to center tap voltage for  $V_{in}$ .

# 1N5820, 1N5821, 1N5822

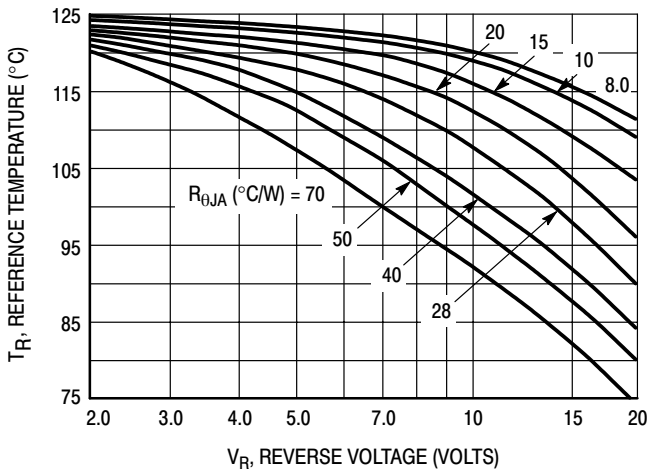

**Figure 1. Maximum Reference Temperature  
1N5820**

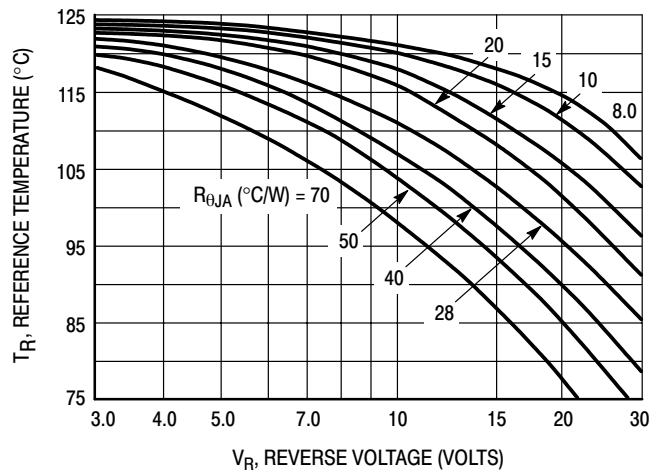

**Figure 2. Maximum Reference Temperature  
1N5821**

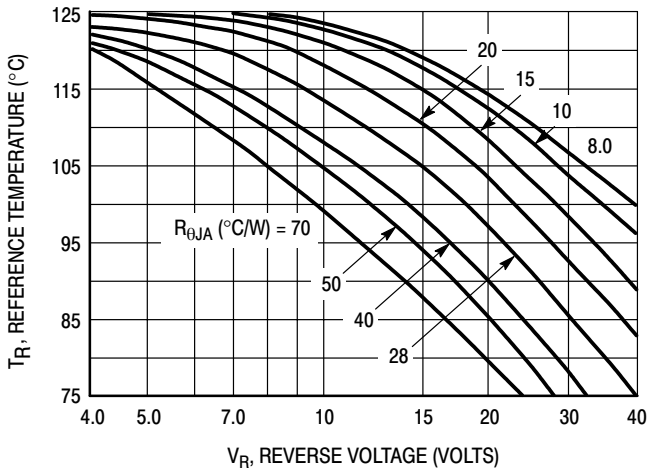

**Figure 3. Maximum Reference Temperature  
1N5822**

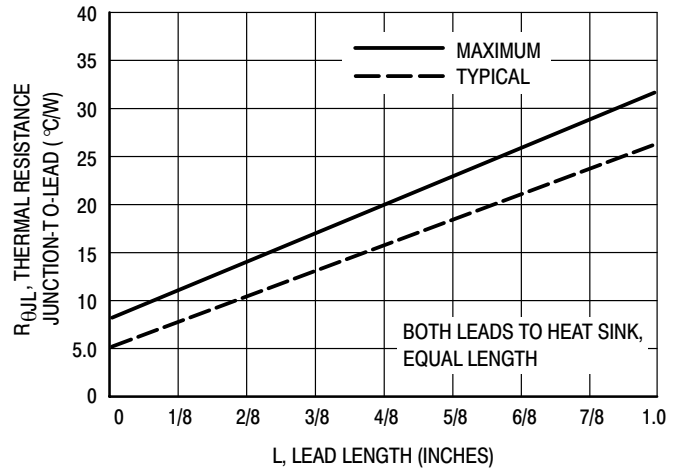

**Figure 4. Steady-State Thermal Resistance**

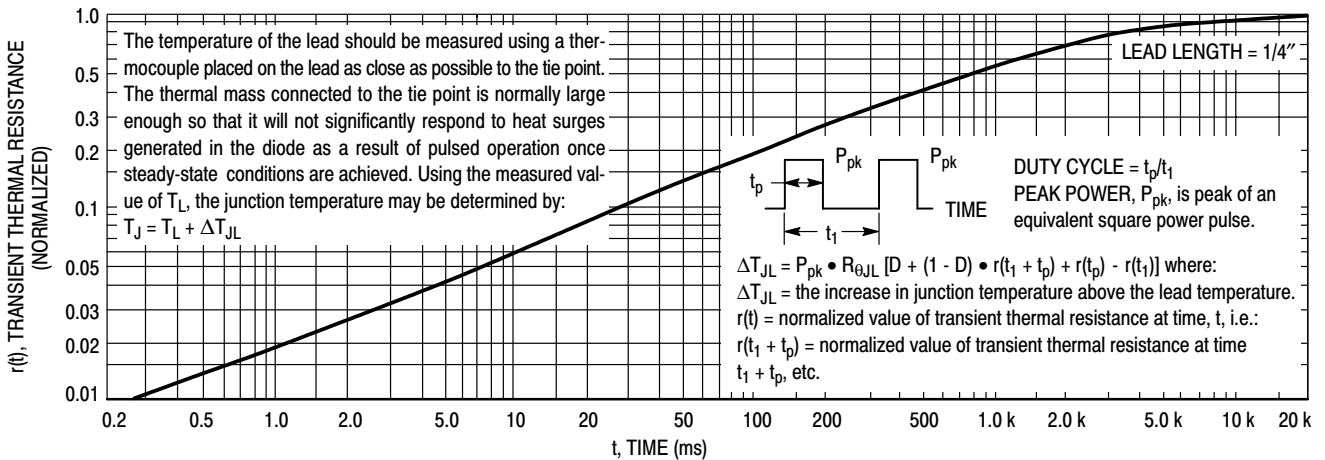

**Figure 5. Thermal Response**

# 1N5820, 1N5821, 1N5822

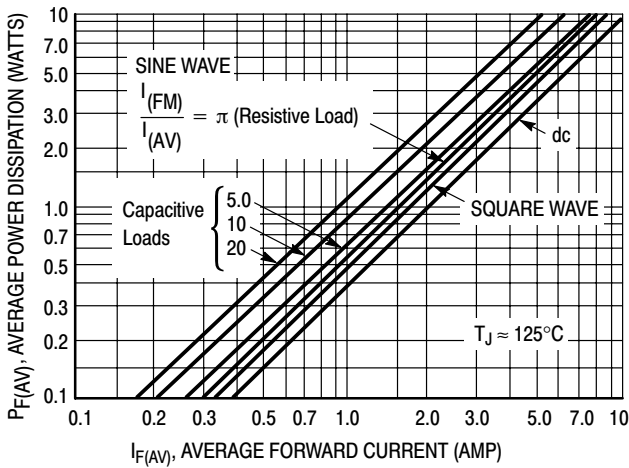
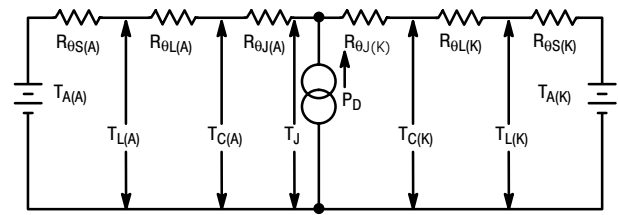

Figure 6. Forward Power Dissipation 1N5820-22

## NOTE 4 - APPROXIMATE THERMAL CIRCUIT MODEL



Use of the above model permits junction to lead thermal resistance for any mounting configuration to be found. For a given total lead length, lowest values occur when one side of the rectifier is brought as close as possible to the heat sink. Terms in the model signify:

- $T_A$  = Ambient Temperature
  - $T_C$  = Case Temperature
  - $T_L$  = Lead Temperature
  - $T_J$  = Junction Temperature
  - $R_{\theta S}$  = Thermal Resistance, Heat Sink to Ambient
  - $R_{\theta L}$  = Thermal Resistance, Lead to Heat Sink
  - $R_{\theta J}$  = Thermal Resistance, Junction to Case
  - $P_D$  = Total Power Dissipation =  $P_F + P_R$
  - $P_F$  = Forward Power Dissipation
  - $P_R$  = Reverse Power Dissipation
- (Subscripts (A) and (K) refer to anode and cathode sides, respectively.) Values for thermal resistance components are:

- $R_{\theta L} = 42^\circ\text{C/W/in}$  typically and  $48^\circ\text{C/W/in}$  maximum
  - $R_{\theta J} = 10^\circ\text{C/W}$  typically and  $16^\circ\text{C/W}$  maximum
- The maximum lead temperature may be found as follows:  
 $T_L = T_{J(\text{max})} - \Delta T_{JL}$   
 where  $\Delta T_{JL} \approx R_{\theta JL} \cdot P_D$

## NOTE 5 — MOUNTING DATA

Data shown for thermal resistance junction-to-ambient ( $R_{\theta JA}$ ) for the mountings shown is to be used as typical guideline values for preliminary engineering, or in case the tie point temperature cannot be measured.

### TYPICAL VALUES FOR $R_{\theta JA}$ IN STILL AIR

Mounting Method	Lead Length, L (in)				$R_{\theta JA}$
	1/8	1/4	1/2	3/4	
1	50	51	53	55	$^\circ\text{C/W}$
2	58	59	61	63	$^\circ\text{C/W}$
3	28				$^\circ\text{C/W}$

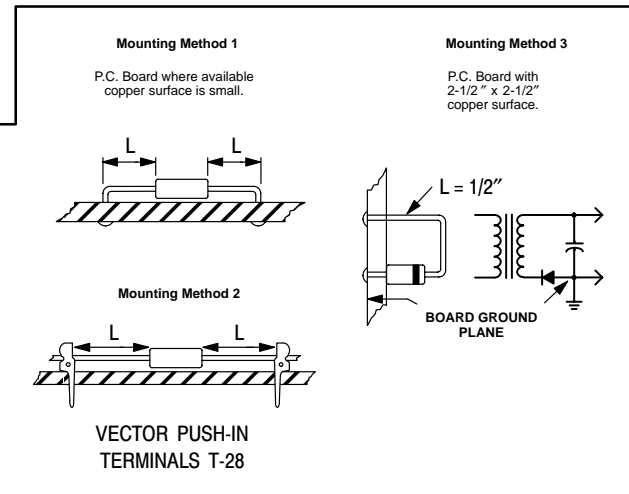

# 1N5820, 1N5821, 1N5822

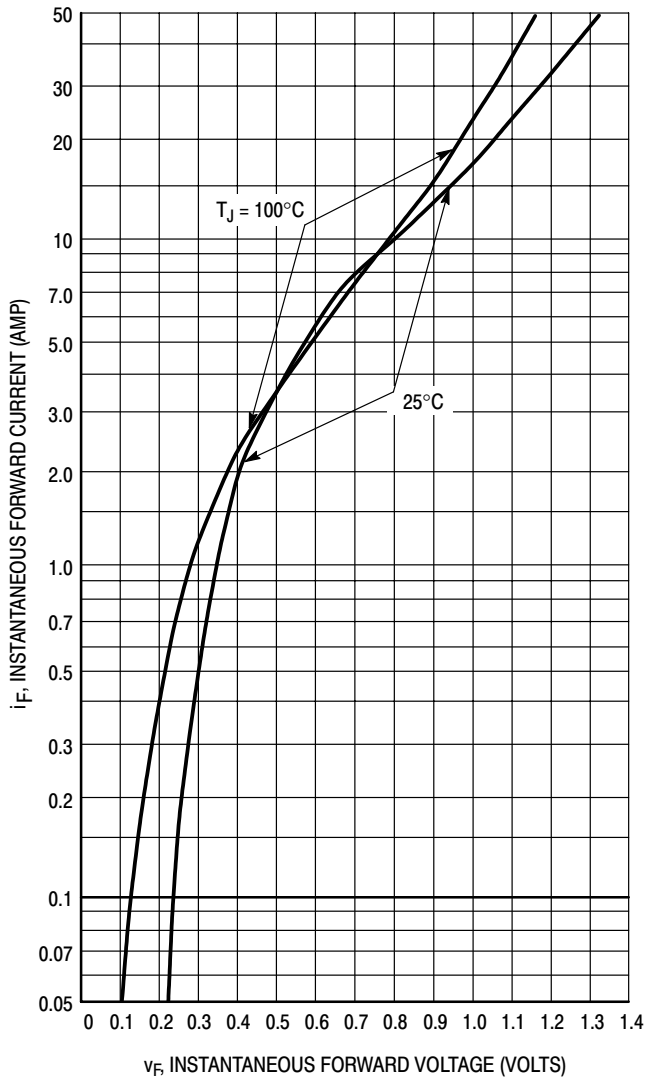

Figure 7. Typical Forward Voltage

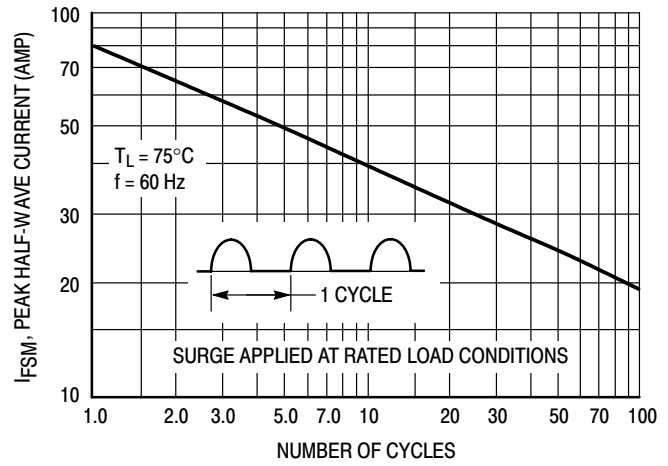

Figure 8. Maximum Non-Repetitive Surge Current

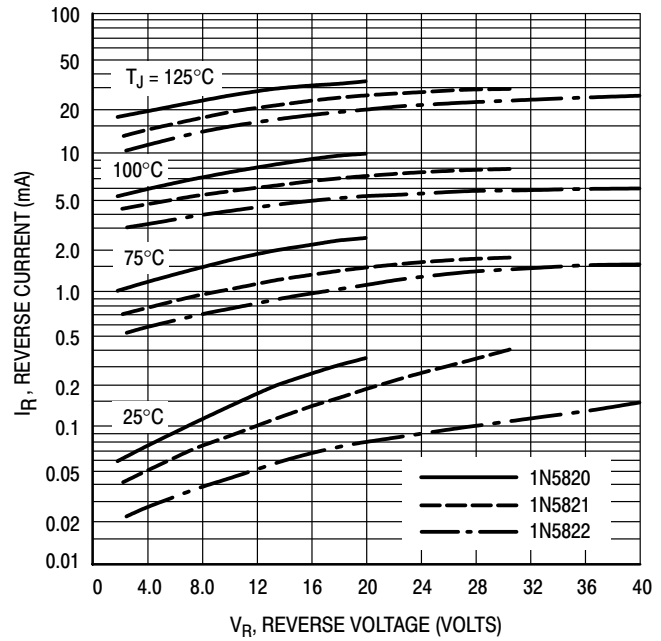

Figure 9. Typical Reverse Current

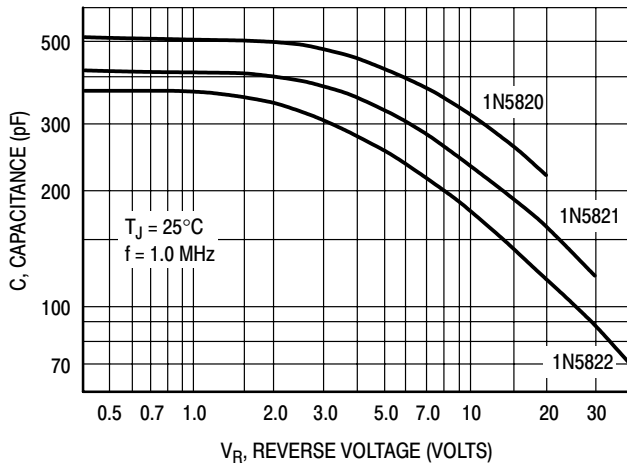

Figure 10. Typical Capacitance

## NOTE 6 — HIGH FREQUENCY OPERATION

Since current flow in a Schottky rectifier is the result of majority carrier conduction, it is not subject to junction diode forward and reverse recovery transients due to minority carrier injection and stored charge. Satisfactory circuit analysis work may be performed by using a model consisting of an ideal diode in parallel with a variable capacitance. (See Figure 10.)

# 1N5820, 1N5821, 1N5822

## PACKAGE DIMENSIONS

AXIAL LEAD  
CASE 267-05  
(DO-201AD)  
ISSUE G

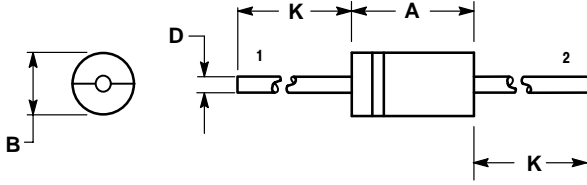

- NOTES:  
1. DIMENSIONING AND TOLERANCING PER ANSI Y14.5M, 1982.  
2. CONTROLLING DIMENSION: INCH.

DIM	INCHES		MILLIMETERS	
	MIN	MAX	MIN	MAX
A	0.287	0.374	7.30	9.50
B	0.189	0.209	4.80	5.30
D	0.047	0.051	1.20	1.30
K	1.000	---	25.40	---

- STYLE 1:  
PIN 1. CATHODE (POLARITY BAND)  
2. ANODE

**ON Semiconductor** and  are registered trademarks of Semiconductor Components Industries, LLC (SCILLC). SCILLC reserves the right to make changes without further notice to any products herein. SCILLC makes no warranty, representation or guarantee regarding the suitability of its products for any particular purpose, nor does SCILLC assume any liability arising out of the application or use of any product or circuit, and specifically disclaims any and all liability, including without limitation special, consequential or incidental damages. "Typical" parameters which may be provided in SCILLC data sheets and/or specifications can and do vary in different applications and actual performance may vary over time. All operating parameters, including "Typicals" must be validated for each customer application by customer's technical experts. SCILLC does not convey any license under its patent rights nor the rights of others. SCILLC products are not designed, intended, or authorized for use as components in systems intended for surgical implant into the body, or other applications intended to support or sustain life, or for any other application in which the failure of the SCILLC product could create a situation where personal injury or death may occur. Should Buyer purchase or use SCILLC products for any such unintended or unauthorized application, Buyer shall indemnify and hold SCILLC and its officers, employees, subsidiaries, affiliates, and distributors harmless against all claims, costs, damages, and expenses, and reasonable attorney fees arising out of, directly or indirectly, any claim of personal injury or death associated with such unintended or unauthorized use, even if such claim alleges that SCILLC was negligent regarding the design or manufacture of the part. SCILLC is an Equal Opportunity/Affirmative Action Employer.

## PUBLICATION ORDERING INFORMATION

### Literature Fulfillment:

Literature Distribution Center for ON Semiconductor  
P.O. Box 5163, Denver, Colorado 80217 USA  
**Phone:** 303-675-2175 or 800-344-3860 Toll Free USA/Canada  
**Fax:** 303-675-2176 or 800-344-3867 Toll Free USA/Canada  
**Email:** ONlit@hibbertco.com

**N. American Technical Support:** 800-282-9855 Toll Free USA/Canada

**JAPAN:** ON Semiconductor, Japan Customer Focus Center  
2-9-1 Kamimeguro, Meguro-ku, Tokyo, Japan 153-0051  
**Phone:** 81-3-5773-3850

**ON Semiconductor Website:** <http://onsemi.com>

For additional information, please contact your local Sales Representative.