



Damper diode  
fast, high-voltage

BY329-1500  
BY329-1500S

**STATIC CHARACTERISTICS**

$T_j = 25\text{ }^\circ\text{C}$  unless otherwise stated

SYMBOL	PARAMETER	CONDITIONS	TYP.		MAX.		UNIT
			1500	1500S	1500	1500S	
$V_F$	Forward voltage	$I_F = 6.5\text{ A}$	1.1	1.3	1.45	1.6	V
$I_R$	Reverse current	$I_F = 6.5\text{ A}; T_j = 125\text{ }^\circ\text{C}$ $V_R = 1300\text{ V}$ $V_R = 1300\text{ V}; T_j = 125\text{ }^\circ\text{C}$	1.05	1.2	1.35	1.5	V
			-	250	-	250	$\mu\text{A}$
			-	1	-	1	mA

**DYNAMIC CHARACTERISTICS**

$T_j = 25\text{ }^\circ\text{C}$  unless otherwise stated

SYMBOL	PARAMETER	CONDITIONS	TYP.		MAX.		UNIT
			1500	1500S	1500	1500S	
$t_{rr}$	Reverse recovery time	$I_F = 1\text{ A}; V_R \geq 30\text{ V};$ $di_F/dt = 50\text{ A}/\mu\text{s}$	0.18	0.13	0.23	0.16	$\mu\text{s}$
$Q_s$	Reverse recovery charge	$I_F = 2\text{ A}; -di_F/dt = 20\text{ A}/\mu\text{s}$	1.6	0.7	2.0	0.95	$\mu\text{C}$
$V_{fr}$	Peak forward recovery voltage	$I_F = 6.5\text{ A}; di_F/dt = 50\text{ A}/\mu\text{s}$	17	23	30	40	V
$t_{fr}$	Forward recovery time	$I_F = 6.5\text{ A}; di_F/dt = 50\text{ A}/\mu\text{s}$	210	220	300	320	ns

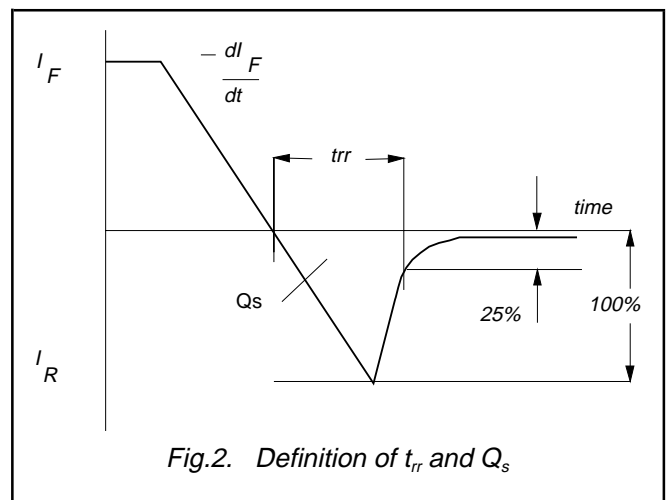
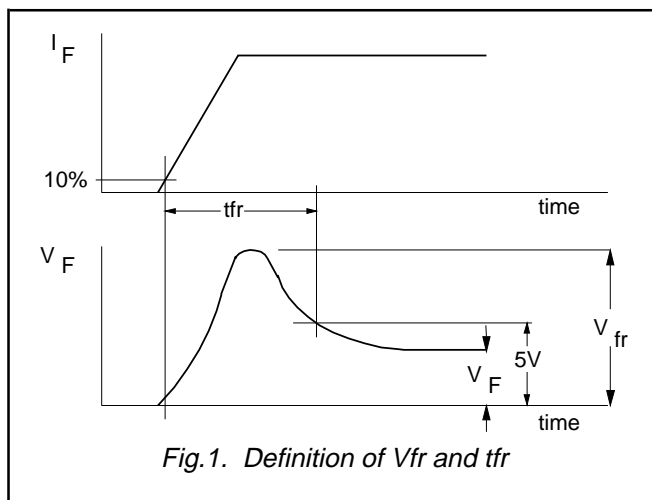

Damper diode  
fast, high-voltage

BY329-1500  
BY329-1500S

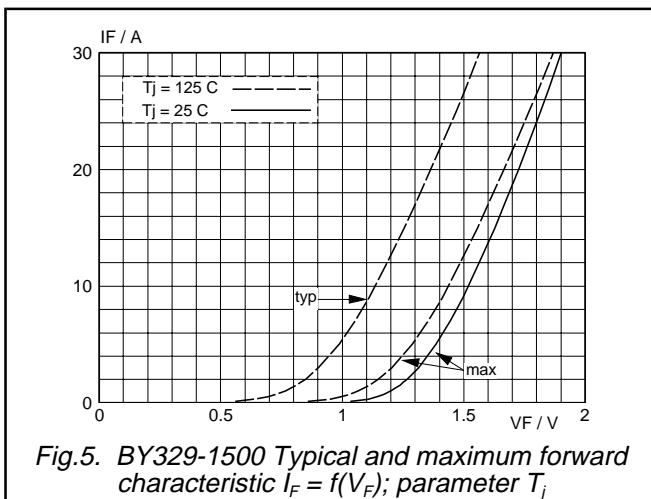
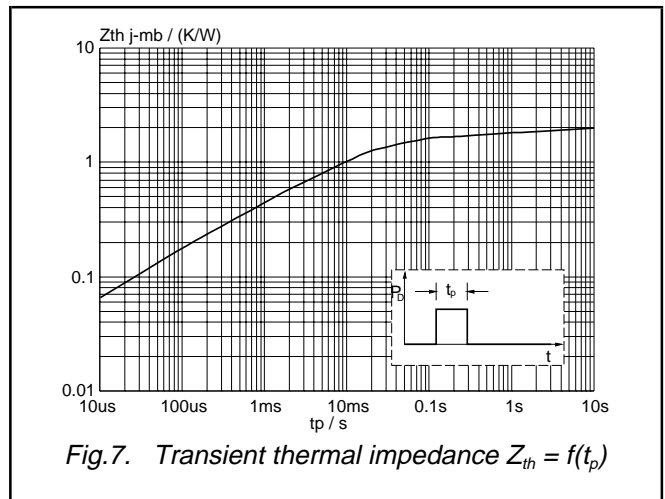
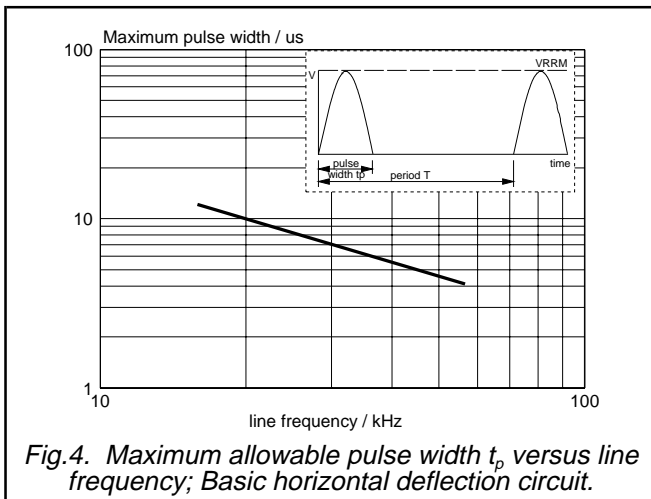
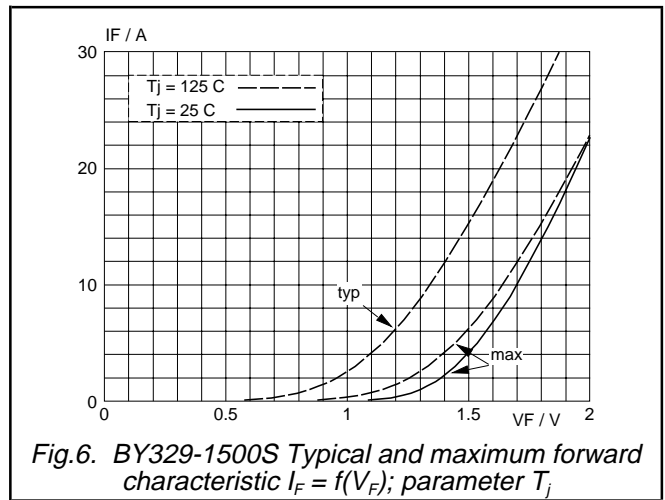
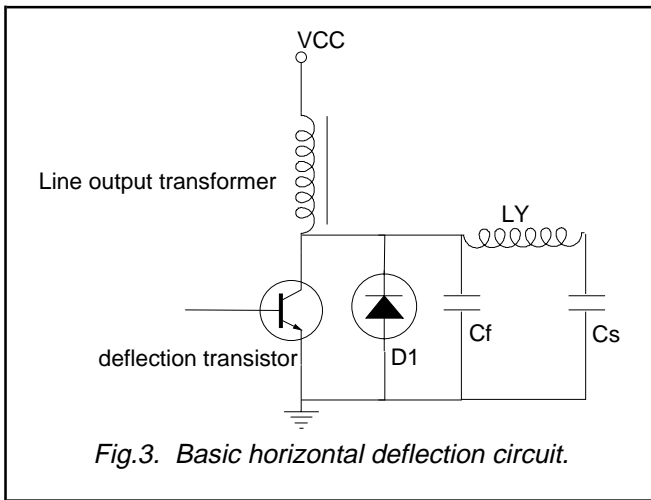

Damper diode  
fast, high-voltage

BY329-1500  
BY329-1500S

**MECHANICAL DATA**

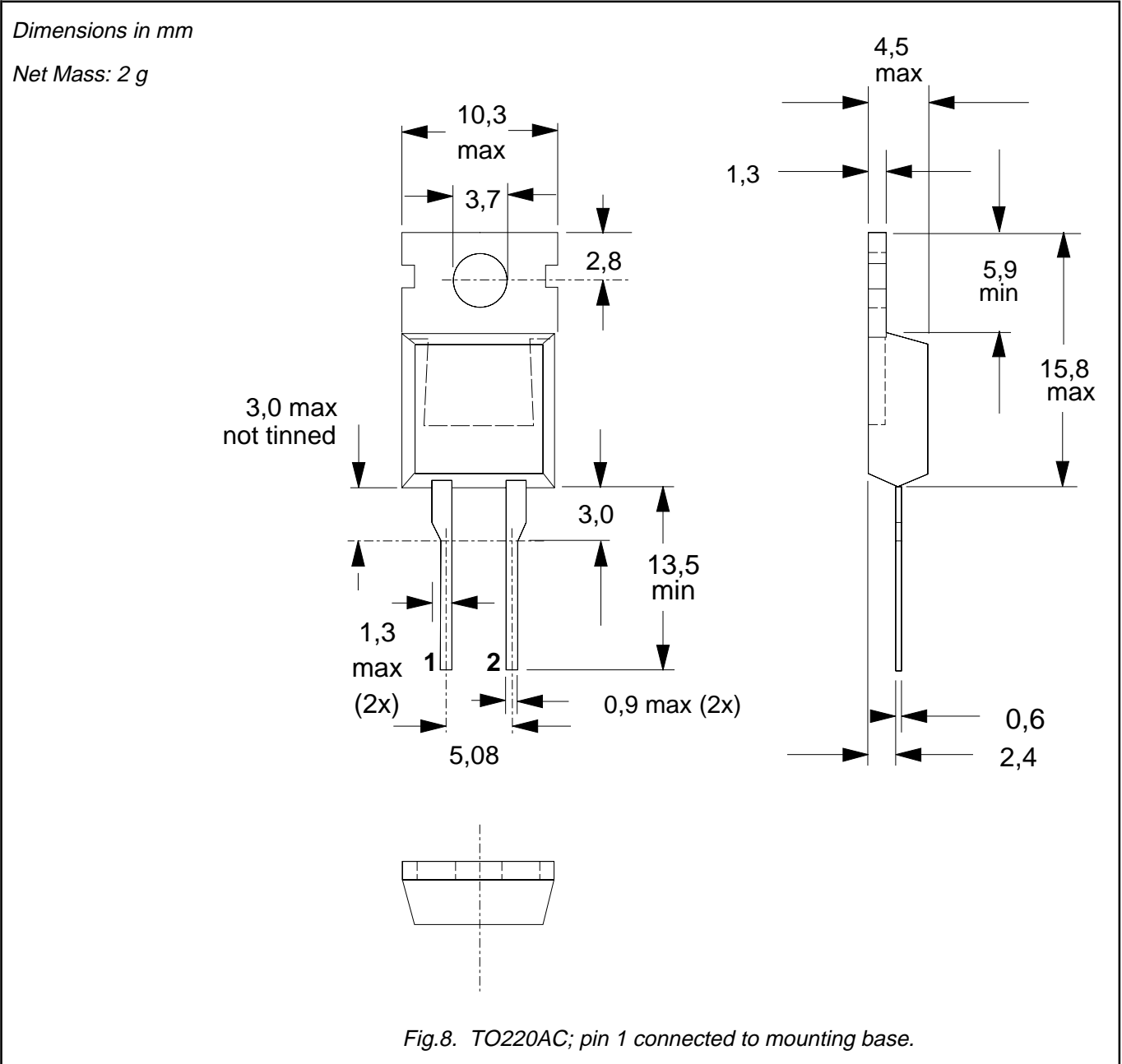

**Notes**

1. Refer to mounting instructions for TO220 envelopes.
2. Epoxy meets UL94 V0 at 1/8".

Damper diode  
fast, high-voltage

BY329-1500  
BY329-1500S

## DEFINITIONS

<b>Data sheet status</b>	
Objective specification	This data sheet contains target or goal specifications for product development.
Preliminary specification	This data sheet contains preliminary data; supplementary data may be published later.
Product specification	This data sheet contains final product specifications.
<b>Limiting values</b>	
Limiting values are given in accordance with the Absolute Maximum Rating System (IEC 134). Stress above one or more of the limiting values may cause permanent damage to the device. These are stress ratings only and operation of the device at these or at any other conditions above those given in the Characteristics sections of this specification is not implied. Exposure to limiting values for extended periods may affect device reliability.	
<b>Application information</b>	
Where application information is given, it is advisory and does not form part of the specification.	
© Philips Electronics N.V. 1997	
All rights are reserved. Reproduction in whole or in part is prohibited without the prior written consent of the copyright owner.	
The information presented in this document does not form part of any quotation or contract, it is believed to be accurate and reliable and may be changed without notice. No liability will be accepted by the publisher for any consequence of its use. Publication thereof does not convey nor imply any license under patent or other industrial or intellectual property rights.	

## LIFE SUPPORT APPLICATIONS

These products are not designed for use in life support appliances, devices or systems where malfunction of these products can be reasonably expected to result in personal injury. Philips customers using or selling these products for use in such applications do so at their own risk and agree to fully indemnify Philips for any damages resulting from such improper use or sale.