



Energy Saving Products

101 N.Sepulveda Blvd, EL Segundo 90245 California, USA

IRAC27951-220W

IRS27951 Evaluation Board User Guide

Table of Contents

1	INTRODUCTION.....	3
2	IRS27951/2 DESCRIPTION.....	3
3	EVALUATION BOARD SPECIFICATIONS	4
3.1	Board Description	4
3.2	Schematic.....	5
3.3	Evaluation Board Picture	5
3.4	Board Component Placement.....	6
3.5	Board PCB Layout	6
3.6	Bill of Materials	7
4	EVALUATION BOARD OPERATING PROCEDURE	8
4.1	Load Connection.....	8
4.2	AC/DC Input	9
4.3	IRS27951 DC Supply Voltage	9
4.4	Power-up Sequence	9
5	SYSTEM PERFORMANCE CHARACTERIZATION	10
5.1	Steady-State and Start-up Waveforms	10
5.2	Short Circuit Protection.....	11
5.3	Dynamic Load Response & Output Voltage Regulation	12
5.4	User Initiated SLEEP Mode	13
5.5	Efficiency Chart.....	13
5.6	Thermal Data.....	14
6	Transformer Spec.....	14
6.1	Electrical Diagram.....	15
6.2	Resonant Transformer Winding Position on Coil former.....	15
6.3	Resonant Transformer Winding Characteristics	15

1 INTRODUCTION

This document details the test procedure for validation of IRS27951 Evaluation Board, featuring the IRS27951 Resonant Half Bridge controller HVIC. The document includes schematic diagram, test setup, test procedure, and test results.

2 IRS27951/2 DESCRIPTION

The IRS2795 is an 8 pin, high-voltage, double-ended controller specific for the resonant half-bridge topology. It provides 50% complementary duty cycle; the high-side and the low-side devices are driven 180° out-of-phase for exactly the same time. The IC incorporates additional protection features for robust operation and provides a high performance solution while minimizing external components, design time, and printed circuit board real estate, all in an **8 pin SOIC package**.

The IC enables the designer to externally program all the following features using a 2 pin oscillator - operating frequency range (minimum and maximum frequency), startup frequency, dead time, soft-start time and sleep mode. Each of these functions are programmed as follows –

The minimum frequency is programmed using RT and CT.

The dead time is programmed using CT.

RSS and CSS program the converter soft-start time.

RSS//RT and CT program the converter start-up frequency.

The converter maximum frequency is set by (Rmax//RT) and CT.

Sleep mode is initiated by pulling the CT/SD to COM.

At start-up, to prevent uncontrolled inrush current, the switching frequency starts from a programmable maximum value and progressively decays until it reaches the steady-state value determined by the control loop. This frequency shift is non linear to minimize output voltage overshoot and its duration is programmable as well. Output voltage regulation is obtained by modulating the operating frequency. An externally programmable dead time is inserted between the turn-OFF of one switch and the turn-ON of the other one allows device zero-voltage turn-on transitions.

IRS2795 uses IR's proprietary high-voltage technology to implement a VS sensing circuitry that monitors the current through the low-side half bridge MOSFET for short circuit faults. By using the $R_{DS(ON)}$ of the low-side MOSFET, the IRS2795 eliminates the need for an additional current sensing resistor, filter and current-sensing pin. This protection feature is latched and the thresholds are fixed at **2V for IRS27951** and **3V for IRS27952**.

Finally, the controller IC also features a micro power startup current ($I_{CC} < 100\mu A$) and a user initiated sleep mode during which the IC power consumption is less than $200\mu A$ (@ $V_{CC} = 15V$). The sleep mode function allows system designs with reduced standby power consumption and can be used to meet stringent energy standards from Blue Angel, Energy Star etc.

3 EVALUATION BOARD¹ SPECIFICATIONS

Input Voltage.....	280VAC or 400V DC
AC Line Frequency Range.....	47 – 63Hz
Converter Switching Frequency Range.....	70-150 kHz
Converter Outputs	24V/6A & 12V/6A
Maximum Output Power.....	220W
Minimum Load Requirement.....	None
Maximum Ambient Operating Temperature.....	40°C ²
Efficiency (@ 220W).....	92%
Short Circuit Protection on both Output Rails.....	Yes
Single Layer PCB with 2oz Copper	

There are high voltages present whenever the board is energized and proper precautions should be taken to avoid potential shock and personal injury.

3.1 Board Description

The evaluation board consists of a front-end AC-DC rectifier stage cascaded with a half-bridge resonant DC-DC converter with multiple output voltage rails (24V and 12V). The front end is a conventional rectifier stage with a rectifier bridge and an EMI filter.

The downstream converter is a multi-resonant half bridge LLC converter whose control is implemented with the IRS27951 (U1) controller HVIC. The controller drives the two half-bridge MOSFETs with a 50 percent fixed duty cycle with dead-time, changing the frequency according to the feedback signal in order to regulate the output voltages against load and input voltage variations. As described earlier, in addition to current protection, all the critical functions needed to control resonant converter designs can be externally programmed using this 8 pin controller IC.

The transformer uses the magnetic integration approach, incorporating the resonant series and shunt inductances in the power transformer. The transformer configuration chosen for the secondary winding is center-tap, and the output rectifiers are Schottky diodes. The feedback loop is implemented by means of a classical configuration using a TL431 (U3) to adjust the current in the optocoupler TLP621 (U2). Weighted resistive dividers from both voltages are summed at the reference node of the TL431 in order to achieve a

¹ Please note that EMI measurements have not been performed on this evaluation board. The primary goal of this board is to verify the functionality of the IRS27951 controller IC.

² A fan is recommended whenever operating at the maximum load for a prolonged period of time.

better overall output voltage regulation. The optocoupler transistor modulates the current from the RT pin of the controller IC to modulate the switching frequency, thus achieving output voltage regulation.

3.2 Schematic

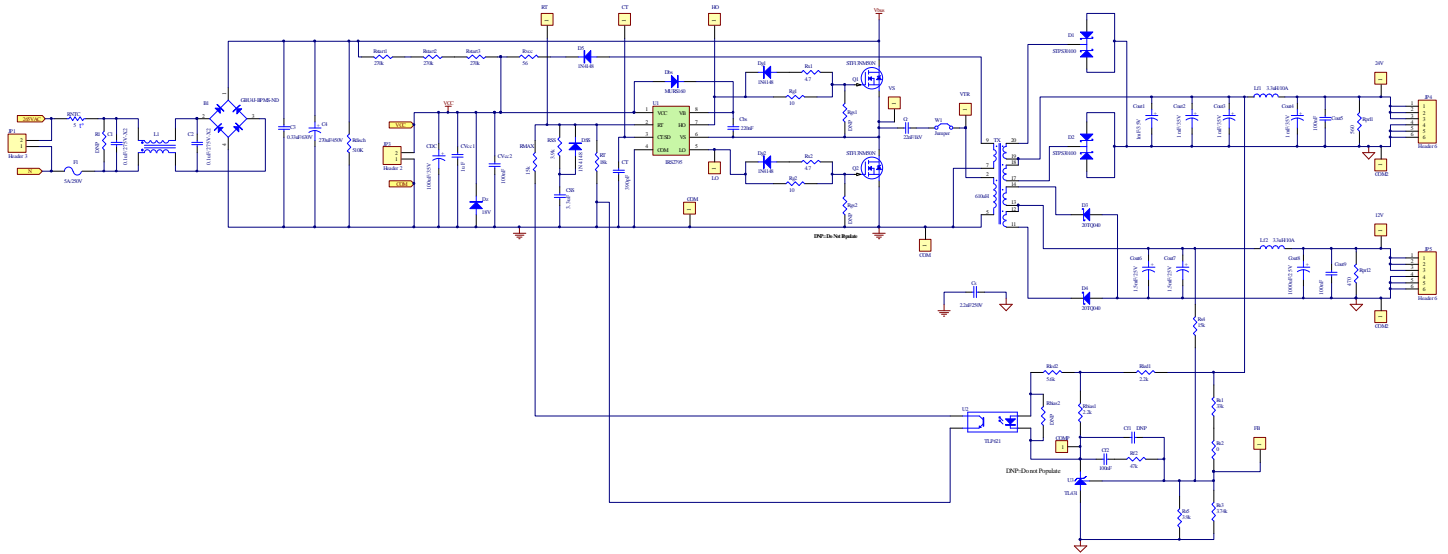

Figure 1 – Evaluation Board Schematic

3.3 Evaluation Board Picture

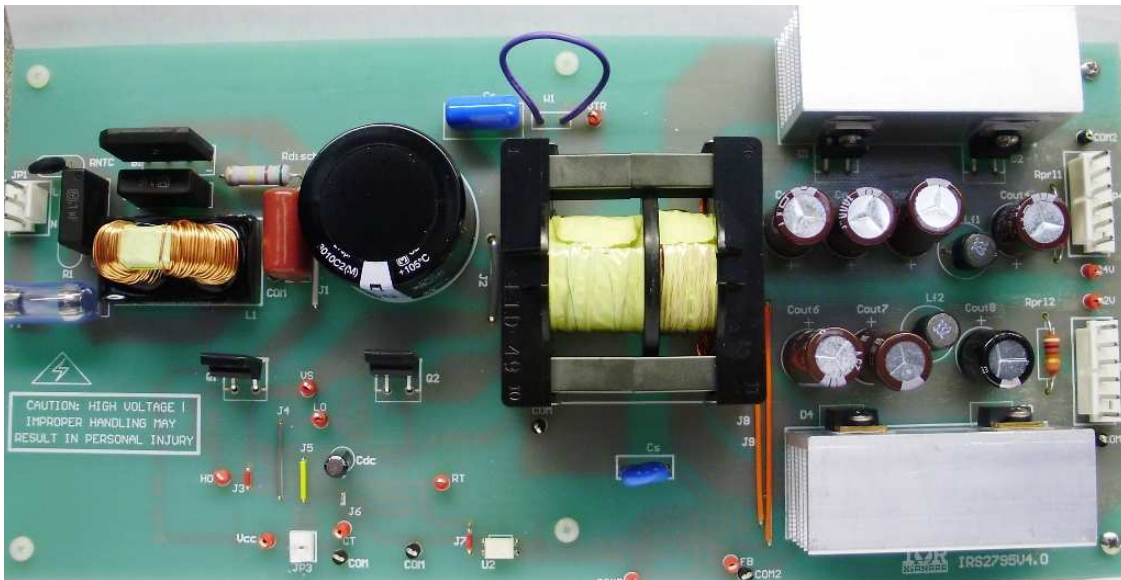

Figure 2 – Evaluation Board Photo

3.4 Board Component Placement

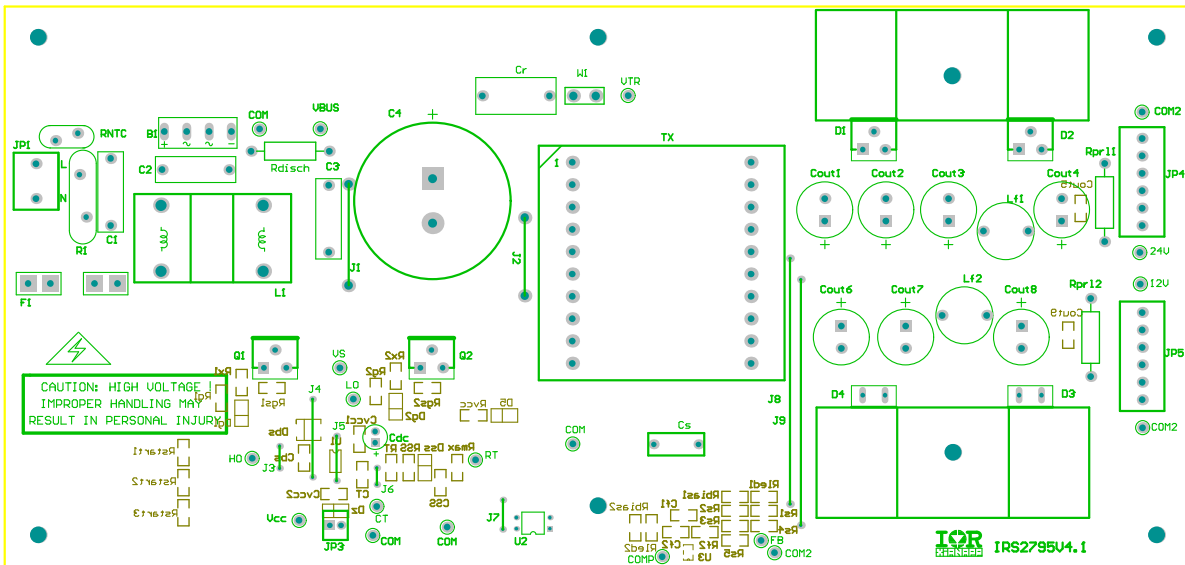

Figure 3 – Evaluation Board Component Placement

3.5 Board PCB Layout

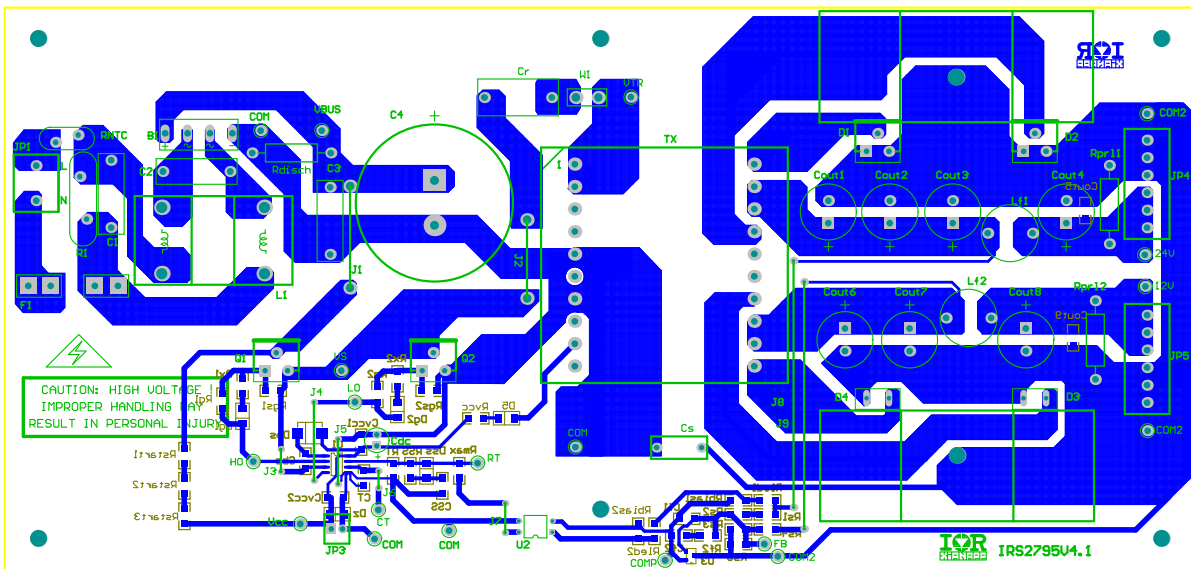

Figure 4 - Board Bottom Layer Copper

3.6 Bill of Materials

Designator	Description	Quantity	Value/Rating	Vendor	Part#
B1	Single Phase Bridge Rectifier	1	600V/4A	DIGIKEY	GBU4J-BPMS-ND
C1, C2	X2 Safety Capacitor	2	100nF/275VAC	DIGIKEY	P10524-ND
C3	Metal Poly Capacitor	1	0.33uF/630V	DIGIKEY	P12245-ND
C4	Electrolytic Bulk Capacitor TS-HC	1	270uF/450V	DIGIKEY	EET-HC2W271LA
Cbs	1206 General Purpose Ceramic SMD	1	220nF/50V	DIGIKEY	490-1776-1-ND
Cf2, Cout5, Cout9, CVcc2	1206 General Purpose Ceramic SMD	4	100nF/50V	DIGIKEY	490-1775-1-ND
CDC	Electrolytic Capacitor FM Radial	1	100uF/35V	DIGIKEY	493-1318-ND
Cf1	Not Used				
Cout1, Cout2, Cout3, Cout4	Aluminium Electrolytic Capacitor 105°C	4	1000uF/35V	DIGIKEY	565-1581-ND
Cout6, Cout7	Aluminium Electrolytic Capacitor 105°C	2	1500uF/25V	DIGIKEY	565-1557-ND
Cout8	Aluminium Electrolytic Capacitor 105°C	1	1000uF/ 25V	DIGIKEY	565-1555-ND
Cr	Polypropylene Capacitor High Ripple	1	22nF/1kV	DIGIKEY	495-3552-ND
Cs	250VAC Y1 Safety Ceramic Disc Capacitor	1	2.2nF/250V	DIGIKEY	445-2411-ND
CSS	1206 General Purpose Ceramic SMD	1	3.3uF/16V	DIGIKEY	445-4038-1-ND
CVcc1	1206 General Purpose Ceramic SMD	1	1uF/25V	DIGIKEY	445-1592-1-ND
CT	1206 General Purpose Ceramic SMD ±5%	1	390pF/50V	DIGIKEY	478-1487-1-ND
D1, D2	TO220AB Power Schottky Rectifier	2	100V/30A	DIGIKEY	STPS30100CT
D3, D4	TO220AC Power Schottky Rectifier	2	40V/20A	DIGIKEY	20TQ040PBF-ND
D5, Dg1, Dg2, DSS	Fast Recovery Diode DO-35	4	75V/0.3A	DIGIKEY	1N4148DICT-ND
Dbs	Fast Rectifier diode SMB	1	600V/1A	DIGIKEY	MURS160-FDICT-ND
Dz	Zener Diode SMD	1	18V/0.5W	DIGIKEY	FLZ18VCCCT-ND
F1	FUSE IEC FA LBC 5x20	1	250V/5A	DIGIKEY	F2395-ND
JP1	CONN HEADER 3POS 0.156 VERT TIN	1		DIGIKEY	WM4621-ND
JP3	CONN HEADER 2POS 0.1 VERT TIN	1		DIGIKEY	WM4200-ND
JP4, JP5	CONN HEADER 6POS 0.156 VERT TIN	2		DIGIKEY	WM4624-ND
L1	EMI Common Mode Choke	1	16mH/2.6A	DIGIKEY	237-1233-ND
Lf1, Lf2	PCV Series Drum Core Inductor 10mm	2	4.7uH/12A	COILCRAFT	PCV-0-472-10L
Q1, Q2	TO-220FP N-Channel Power MOSFET	2	500V/12A	DIGIKEY	STF13NM50N
R1, Rbias2, Rgs1, Rgs2	Not Used				
Rbias1, Rled1	1206 SMD Film RED 1/4W 1%	2	2.2k	DIGIKEY	RHM2.20kFCT-ND
Rdisch	Metal Film Power Resistor 2W 5%	1	510k	DIGIKEY	BC510KW-2CT-ND
Rf2	1206 SMD Film RED 1/4W 1%	1	47k	DIGIKEY	RHM47.0kFCT-ND
Rg1, Rg2	1206 SMD Film RED 1/4W 5%	2	10	DIGIKEY	RHM10ERCT-ND
Rled2	1206 SMD Film RED 1/4W 1%	1	5.6k	DIGIKEY	RHM5.60kFCT-ND
RMAX	1206 SMD Film RED 1/4W 1%	1	15k	DIGIKEY	RHM15.0kFCT-ND
RNTC	Inrush Current Limiter	1	5	DIGIKEY	495-2093-ND
Rpr1	Metal Film Power Resistor 2W 5%	1	560	DIGIKEY	PPC560W-2CT-ND
Rpr2	Metal Film Power Resistor 2W 5%	1	470	DIGIKEY	PPC470W-2CT-ND
Rs1	1206 SMD Film RED 1/4W 1%	1	33k	DIGIKEY	RHM33.0kFCT-ND
Rs2	1206 SMD Film RED 1/4W 1%	1	0	DIGIKEY	P0.0ECT-ND
Rs3	1206 SMD Film RED 1/4W 1%	1	3.74k	DIGIKEY	RHM3.74kFCT-ND
Rs4	1206 SMD Film RED 1/4W 1%	1	15k	DIGIKEY	RHM15.0kFCT-ND
Rs5, RSS	1206 SMD Film RED 1/4W 1%	2	3.9k	DIGIKEY	RHM3.90kFCT-ND
Rstart1, Rstart2, Rstart3	1206 SMD Film RED 1/4W 1%	3	270k	DIGIKEY	RHM270kFCT-ND
RT	1206 SMD Film RED 1/4W 1%	1	18k	DIGIKEY	RHM18.0kFCT-ND
Rvcc	1206 SMD Film RED 1/4W 5%	1	56	DIGIKEY	RHM56ERCT-ND
Rx1, Rx2	1206 SMD Film RED 1/4W 5%	2	4.7	DIGIKEY	RHM4.7ERCT-ND
TX	Resonant Power Transformer	1	ETD49	PRECISION INC	019-4974-00R
U1	IRS27951 Control IC	1		IR	IRS27951S
U2	Photocoupler TRANS-OUT 4-DIP	1	TLP621	DIGIKEY	TLP621FT-ND
U3	Programmable Voltage Regulator SOT23-3	1	TL431	DIGIKEY	296-17328-1-ND
W1	Jumper for Primary Current Sensing Loop	1			AWG22, multi strands

4 EVALUATION BOARD OPERATING PROCEDURE

CAUTION: Potentially lethal voltages exist on this demo board when powered up. Improper or unsafe handling of this board may result in serious injury or death.

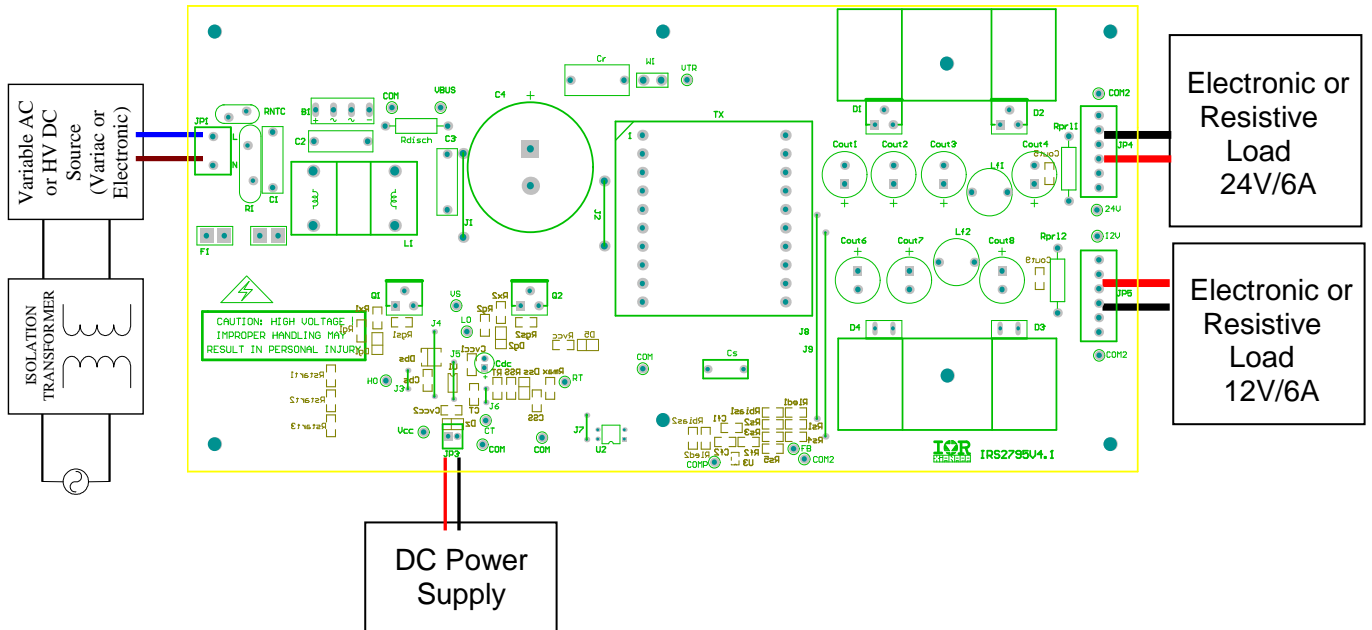

Figure 5 - Recommended Evaluation Board Test Setup

4.1 Load Connection

Connect a resistive or electronic load, capable of 150W continuous power on the 24V rail to connector JP4 and a 75W continuous power load on the 12V output rail to JP5. Please note that there is no minimum load³ requirement for this board.

³ A minimum load has been added on both the output rails to ensure tight voltage regulation for both output rails from no load to full load.

4.2 AC/DC Input

The use of an isolation transformer on the AC side is highly recommended, so that all the control signals on the test points can easily be probed by using regular scope probes

Connect a 60Hz AC power source capable of operation up to 280VAC or a 400V DC source to JP1. The converter can keep the output regulated when the BUS voltage is in the range of 350V DC to 420V DC.

The NTC resistor limits the inrush current upon initial application of full AC line voltage. Once power is applied to demo board, potentially lethal high voltages will be present on board and necessary precautions should be taken to avoid serious injury.

4.3 IRS27951 DC Supply Voltage

The board is self-supplied by startup circuit and auxiliary winding of transformer. The startup circuit starts to work once AC or DC input voltage applies to the board. However, the Vcc will be stable only when BUS voltage is 350Vdc or above. The VCC voltage is monitored at test points VCC and COM.

If you choose to supply VCC voltage using external DC power supply (in order to study IC VCC UVLO features etc.) then simply provide DC voltage to connector JP3 or alternatively between Test Points V_{CC} and COM. You should also dis-connect R_{vcc} and R_{start} in order to measure the Vcc supply current from the DC source. The minimum supply voltage recommended is 12V while a maximum voltage of 18V can be applied without damaging the IC. The location of the DC power connector and controller IC is shown in Figure 6.

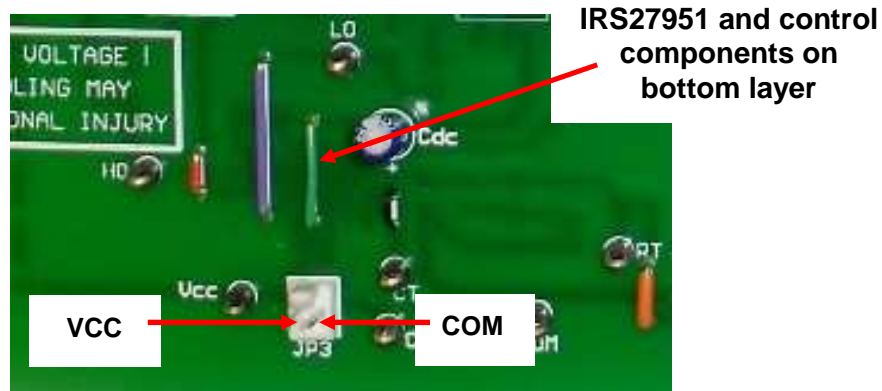

Figure 6 - VCC connector and test points

4.4 Power-up Sequence

Once all the connections are made, the system can be powered up. When using external DC supply to bias Vcc, power-up the AC supply or 400V DC supply first and then the Vcc circuitry. This sequence is necessary to ensure soft start operation of the DC-DC converter.

5 SYSTEM PERFORMANCE CHARACTERIZATION

Test Conditions – $V_{IN}=400V$ DC; Full Load (24V/6A, 12V/6A); No Load (24V/0A, 12V/0A)

5.1 Steady-State and Start-up Waveforms

Ch 1: Low-side device V_{GS} – **Ch 2:** Voltage at VS pin
Ch 4: Resonant tank current

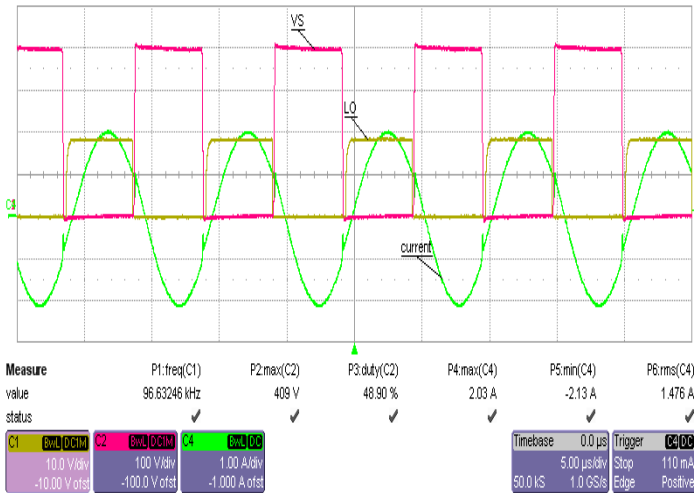

Full Load Operation

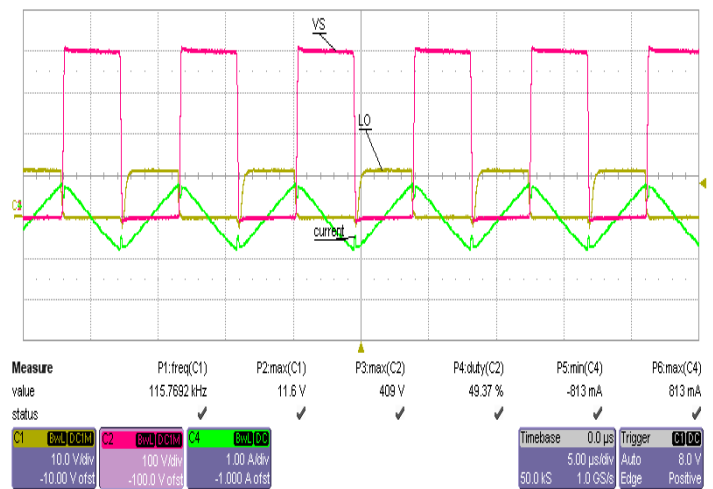

No Load Operation

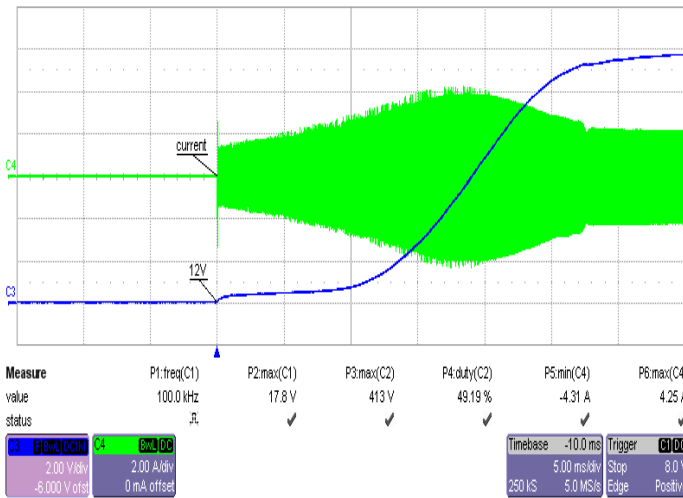

Full Load Start-up

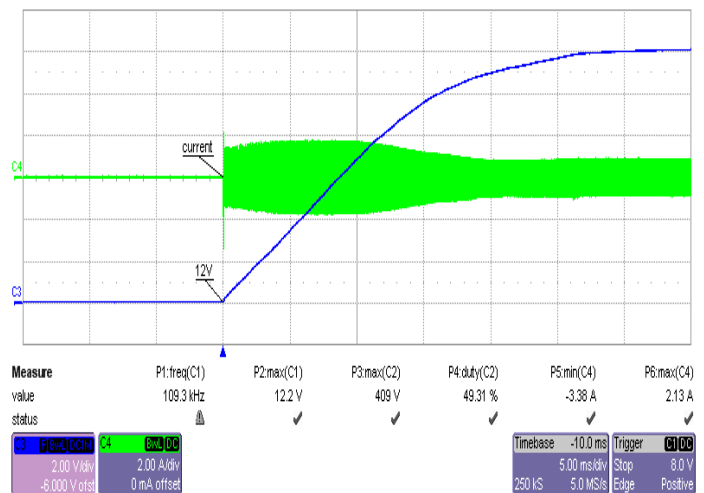

No Load Start-up

5.2 Short Circuit Protection

IRS27951 uses high-voltage technology to sense the current in the low-side MOSFET. The voltage at the VS node is sensed when the low-side device is turned ON and the system shuts off when a load short-circuit condition is sensed (i.e. $I_D \cdot R_{DS(ON)}$ exceeds the fixed internal threshold).

Ch 1: Low-side device V_{GS}

Ch 3: Output Voltage **Ch 4:** Resonant tank current

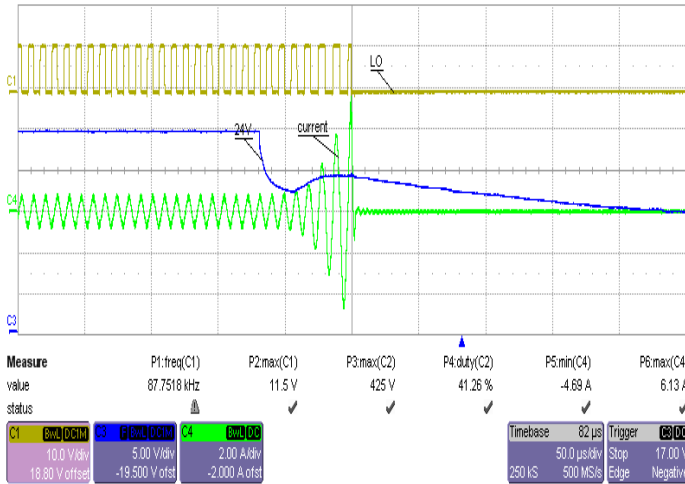

24V Rail short-circuit

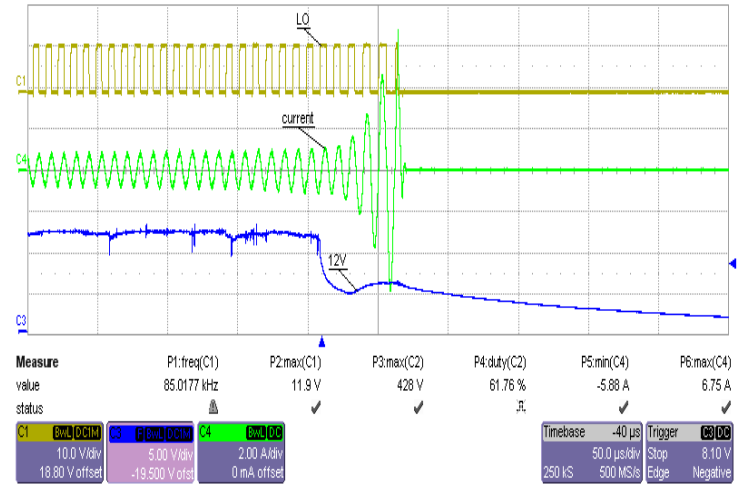

12V Rail short circuit

5.3 Dynamic Load Response & Output Voltage Regulation

A load step from full load to no load and no load to full load was applied to test the dynamic response of the system. The output voltage is tightly regulated within a 3% regulation band over the entire line load range. A summary of the load performance is also shown below.

Ch 3: 24V Rail output voltage **Ch 2:** 12V Rail output voltage

Ch 4: Resonant tank current

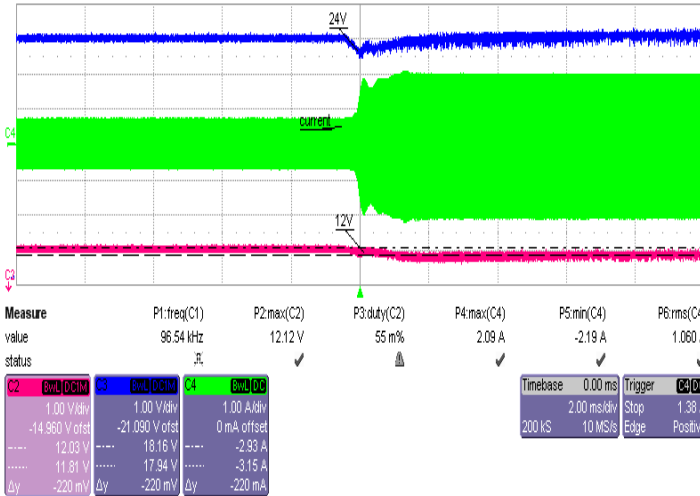

No Load to Full Load Step

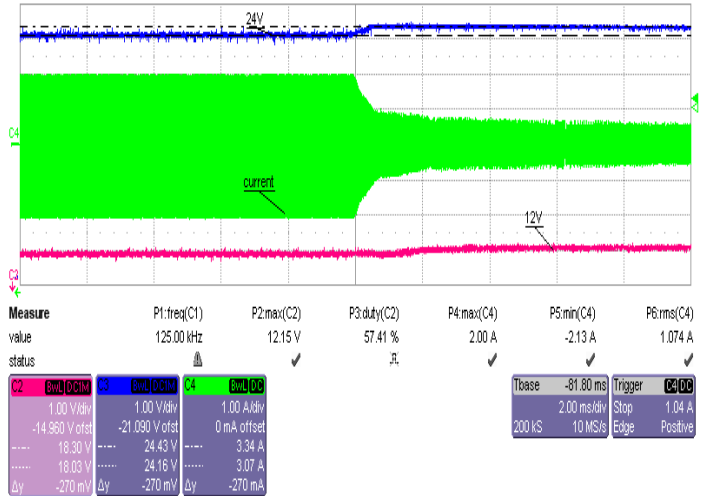

Full Load to No Load Step

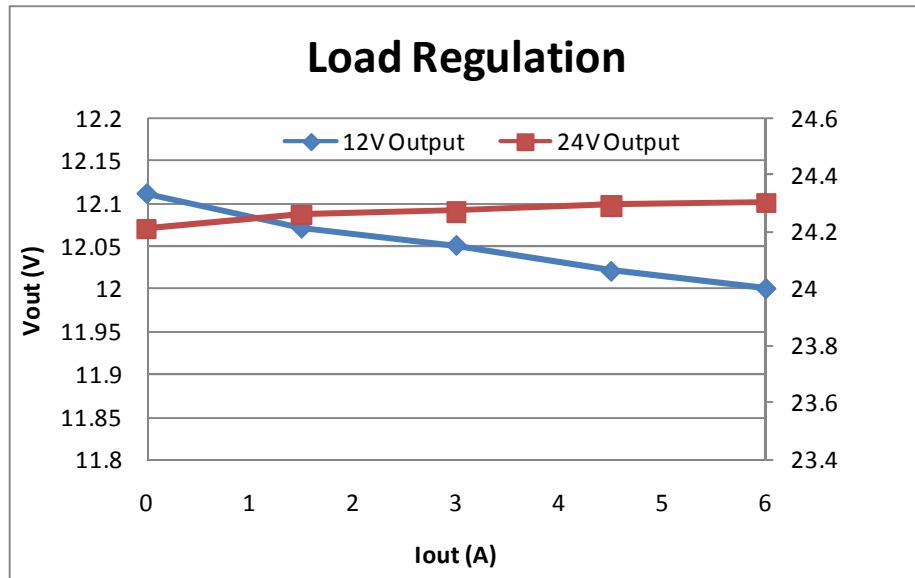
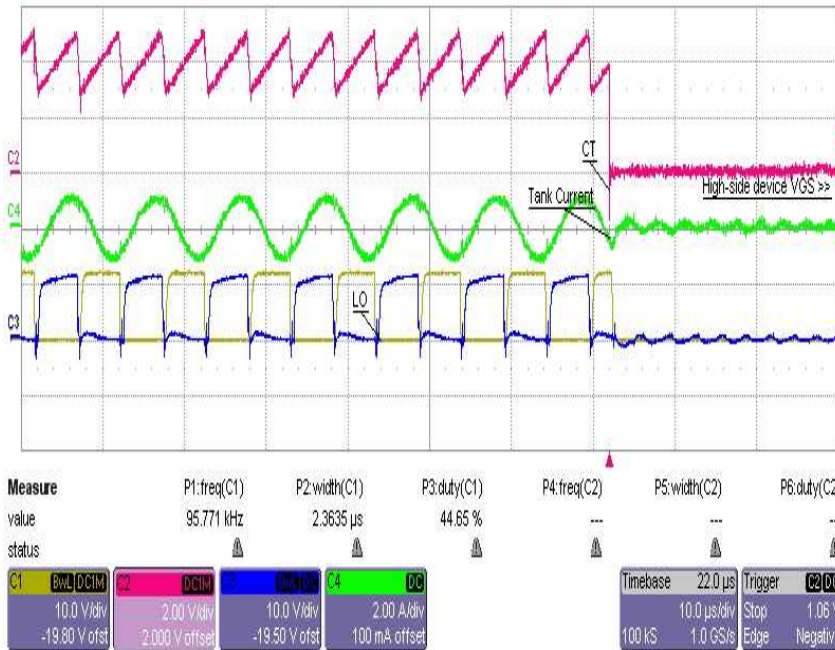

Figure 7 - Output voltage regulation plot

5.4 User Initiated SLEEP Mode

The CT/SD pin of IRS27951 can be used to disable the IC and enter sleep mode in which the IC power consumption is highly minimized. The IC enters this mode when the CT/SD pin is externally pulled to COM. This feature facilitates the implementation of system power management functions for reducing overall standby power consumption by disabling the down converter when no power is being requested by the converter main output voltage rails.



- Ch 1:** Low-side device V_{GS}
- Ch 2:** CT/SD pin of IRS27951
- Ch 3:** High-side device V_{GS}
- Ch 4:** Resonant tank current

Sleep mode initiated by externally pulling the CT/SD pin to COM

5.5 Efficiency Chart

The efficiency of IRS27951 demo board was tested at 270Vac input over the load range. The result is shown in the table below.

$V_{in}(ac)$	24Vout	24V current(A)	12Vout	12V current (A)	Pout(W)	Pin(W)	Efficiency
270	24.26	1.5	12.07	1.5	54.5	61.1	89.2%
	24.27	3	12.05	3	109.0	119	91.6%
	24.29	4.5	12.02	4.5	163.4	178	91.8%
	24.3	6	12	6	217.8	239	91.1%
	23.51	6	12.41	0	141.1	155	91.0%
	24.89	0	11.75	6	70.5	79.7	88.5%

The average efficiency of the board at 25%, 50%, 75% and 100% load is 91% at 270Vac input. The efficiency at 400Vdc input is higher and reaches 92% at full load.

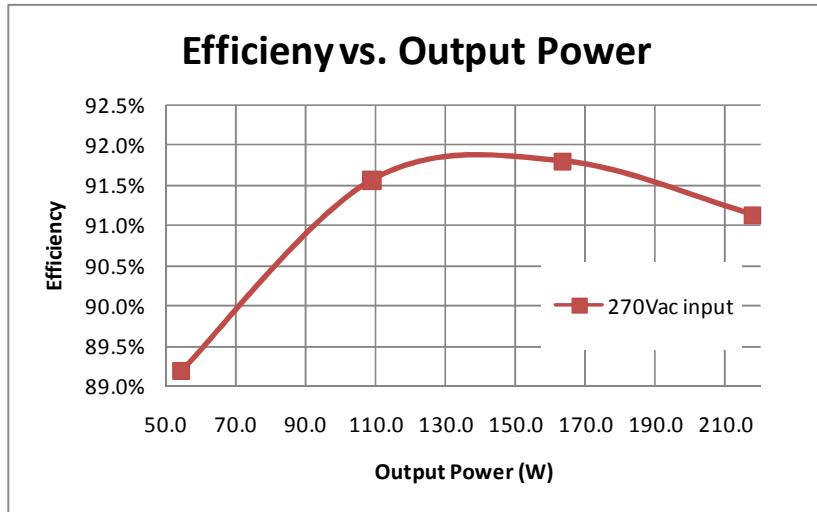

Figure 8 - Efficiency plot

5.6 Thermal Data

The thermal performance of IRS27951 demo board is tested at 400Vdc input and 220W full load under room temperature.

Part	Case Temperature (°C)
MOSFET Q1	63
MOSFET Q2	57
U1 IRS27951	46
Transformer	78
24V diodes	73
12V diodes	58

6 Transformer Spec

Core type: ETD49 - 0R44949EC

Minimum operating frequency: 80 kHz

Primary inductance: 585 μ H \pm 10% @1 kHz - 0.25V (*Note 1*)

Leakage inductance: 133 μ H \pm 10% @1 kHz - 0.25V (*Note 2*)

Note: 1 Measured between Pins 2 and 5

Note: 2 Measured between Pins 2 and 5 with secondary windings shorted

6.1 Electrical Diagram

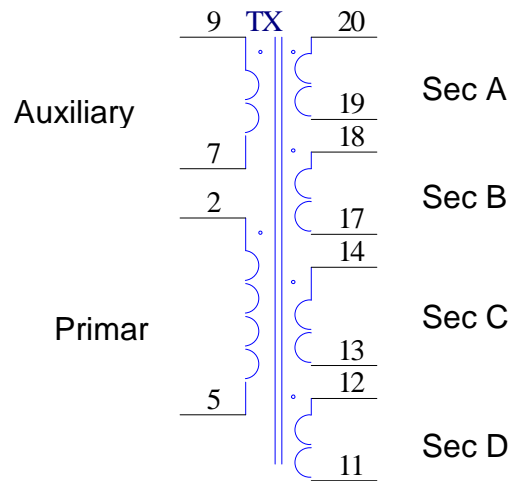

Note: pin19 is shorted to pin18 on PCB, pin13 is shorted to pin12 on PCB.

6.2 Resonant Transformer Winding Position on Coil former

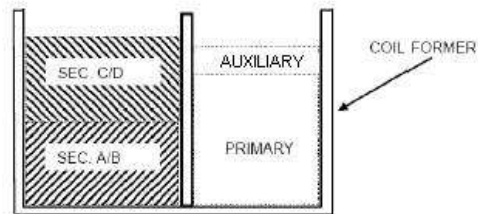

6.3 Resonant Transformer Winding Characteristics

Pins	Winding	Turn number	RMS Current	Wire type [mm]
2 - 5	Primary	36	1.8A	LITZ - dia. 0.15x30
9 - 7	Auxiliary	2	0.1A	Dia. 0.2
20 - 19	Sec. A	4	7A	LITZ - dia. 0.20x40
18 - 17	Sec. B	4	7A	LITZ - dia. 0.20x40
14 - 13	Sec. C	2	7A	LITZ - dia. 0.20x40
12 - 11	Sec. D	2	7A	LITZ - dia. 0.20x40