

SINGLE 9-A HIGH SPEED LOW-SIDE MOSFET DRIVER WITH ENABLE

FEATURES

- Industry-Standard Pin-Out With Addition of Enable Function
- High-Peak Current Drive Capability of ± 9 A at the Miller Plateau Region Using TrueDrive
- Efficient Constant Current Sourcing Using a Unique BiPolar & CMOS Output Stage
- TTL/CMOS Compatible Inputs Independent of Supply Voltage
- 20-ns Typical Rise and Fall Times with 10-nF Load
- Typical Propagation Delay Times of 25 ns With Input Falling and 35 ns with Input Rising
- 4-V to 15-V Supply Voltage
- Available in Thermally Enhanced MSOP PowerPAD™ Package With 4.7°C/W θ_{jc}
- Rated From -40°C to 105°C
- Pb-Free Finish (NiPdAu) on SOIC-8 and PDIP-8 Packages

APPLICATIONS

- Switch Mode Power Supplies
- DC/DC Converters
- Motor Controllers
- Class-D Switching Amplifiers
- Line Drivers
- Pulse Transformer Driver

DESCRIPTION

The UCC37321/2 family of high-speed drivers deliver 9 A of peak drive current in an industry standard pinout. These drivers can drive the largest of MOSFETs for systems requiring extreme Miller current due to high dV/dt transitions. This eliminates additional external circuits and can replace multiple components to reduce space, design complexity and assembly cost. Two standard logic options are offered, inverting (UCC37321) and noninverting (UCC37322).

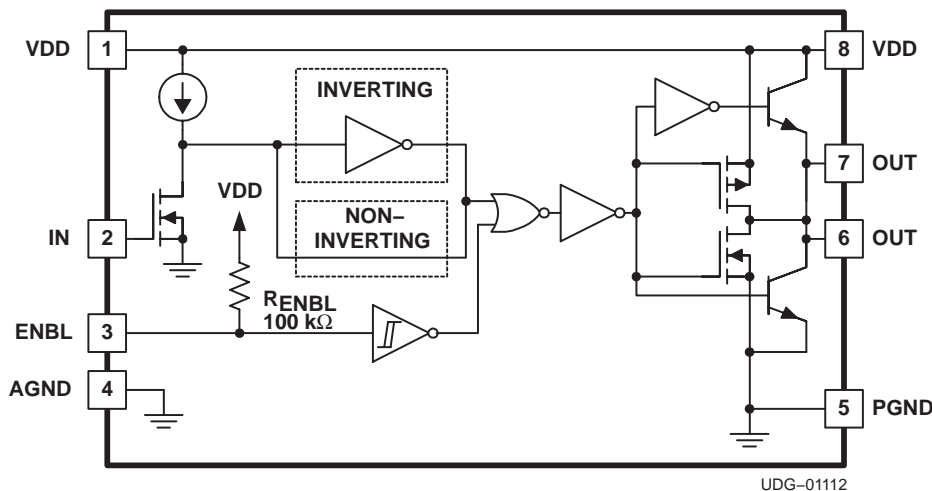

INPUT/OUTPUT TABLE

	ENBL	IN	OUT
INVERTING UCC37321	0	0	0
	0	1	0
	1	0	1
	1	1	0
NON- INVERTING UCC37322	0	0	0
	0	1	0
	1	0	0
	1	1	1



Please be aware that an important notice concerning availability, standard warranty, and use in critical applications of Texas Instruments semiconductor products and disclaimers thereto appears at the end of this data sheet.

PowerPAD™ is trademarks of Texas Instruments Incorporated.

PRODUCTION DATA information is current as of publication date. Products conform to specifications per the terms of Texas Instruments standard warranty. Production processing does not necessarily include testing of all parameters.

UCC27321, UCC27322 UCC37321, UCC37322

SLUS504C – SEPTEMBER 2002 – REVISED NOVEMBER 2004

description (continued)

Using a design that inherently minimizes shoot-through current, the outputs of these can provide high gate drive current where it is most needed at the Miller plateau region during the MOSFET switching transition. A unique hybrid output stage paralleling bipolar and MOSFET transistors (TrueDrive) allows efficient current delivery at low supply voltages. With this drive architecture, UCC37321/2/3 can be used in industry standard 6-A, 9-A and many 12-A driver applications. Latch up and ESD protection circuitries are also included. Finally, the UCC37321/2 provides an enable (ENBL) function to have better control of the operation of the driver applications. ENBL is implemented on pin 3 which was previously left unused in the industry standard pin-out. It is internally pulled up to V_{DD} for active high logic and can be left open for standard operation.

In addition to SOIC-8 (D) and PDIP-8 (P) package offerings, the UCC37321/2 also comes in the thermally enhanced but tiny 8-pin MSOP PowerPAD™ (DGN) package. The PowerPAD™ package drastically lowers the thermal resistance to extend the temperature operation range and improve the long-term reliability.

absolute maximum ratings over operating free-air temperature (unless otherwise noted)^{†‡}

	UCCx732x	UNIT
Supply voltage, V _{DD}	-0.3 to 16	V
Output current (OUT) DC, I _{OUT_DC}	0.6	A
Input voltage (IN), V _{IN}	-5 V to 6 V or V _{DD} +0.3 (whichever is larger)	V
Enable voltage (ENBL)	-0.3 V to 6 V or V _{DD} +0.3 (whichever is larger)	
Power dissipation at T _A = 25°C		
D package	650	mW
DGN package	3	W
P package	350	mW
Junction operating temperature, T _J	-55 to 150	°C
Storage temperature, T _{stg}	-65 to 150	°C
Lead temperature (soldering, 10 sec.)	300	°C

[†] Stresses beyond those listed under “absolute maximum ratings” may cause permanent damage to the device. These are stress ratings only, and functional operation of the device at these or any other conditions beyond those indicated under “recommended operating conditions” is not implied. Exposure to absolute-maximum-rated conditions for extended periods may affect device reliability.

[‡] All voltages are with respect to GND. Currents are positive into, negative out of the specified terminal.

ordering information

OUTPUT CONFIGURATION	TEMPERATURE RANGE T _A = T _J	PACKAGED DEVICES		
		SOIC-8 (D)	MSOP-8 PowerPAD (DGN)	PDIP-8 (P)
Inverting	-40°C to +105°C	UCC27321D	UCC27321DGN	UCC27321P
	0°C to +70°C	UCC37321D	UCC37321DGN	UCC37321P
NonInverting	-40°C to +105°C	UCC27322D	UCC27322DGN	UCC27322P
	0°C to +70°C	UCC37322D	UCC37322DGN	UCC37322P

[†] D (SOIC-8) and DGN (PowerPAD-MSOP) packages are available taped and reeled. Add R suffix to device type (e.g. UCC37321DR, UCC37322DGNR) to order quantities of 2,500 devices per reel.

electrical characteristics, $V_{DD} = 4.5\text{ V to }15\text{ V}$, $T_A = -40^\circ\text{C to }105^\circ\text{C}$ for UCC2732x, $T_A = 0^\circ\text{C to }70^\circ\text{C}$ for UCC3732x, $T_A = T_J$, (unless otherwise noted)

input (IN)

PARAMETER	TEST CONDITION	MIN	TYP	MAX	UNITS
V_{IN_H} , logic 1 input threshold		2			V
V_{IN_L} , logic 0 input threshold				1	V
Input current	$0\text{ V} \leq V_{IN} \leq V_{DD}$	-10	0	10	μA

output (OUT)

PARAMETER	TEST CONDITION	MIN	TYP	MAX	UNITS
Peak output current ⁽¹⁾⁽²⁾	$V_{DD} = 14\text{ V}$,		9		A
V_{OH} , output high level	$V_{OH} = V_{DD} - V_{OUT}$, $I_{OUT} = -10\text{ mA}$		150	300	mV
V_{OL} , output low level	$I_{OUT} = 10\text{ mA}$		11	25	mV
Output resistance high ⁽³⁾	$I_{OUT} = -10\text{ mA}$, $V_{DD} = 14\text{ V}$		15	25	Ω
Output resistance low ⁽³⁾	$I_{OUT} = 10\text{ mA}$, $V_{DD} = 14\text{ V}$		1.1	2.5	Ω
latch-up protection ⁽¹⁾		500			mA

overall

PARAMETER	TEST CONDITION	MIN	TYP	MAX	UNITS	
I_{DD} , static operating current	UCC37321 UCC27321	IN = LO, EN = LO, $V_{DD} = 15\text{ V}$		150	225	μA
		IN = HI, EN = LO, $V_{DD} = 15\text{ V}$		440	650	
		IN = LO, EN = HI, $V_{DD} = 15\text{ V}$		370	550	
		IN = HI, EN = HI, $V_{DD} = 15\text{ V}$		370	550	
	UCC37322 UCC27322	IN = LO, EN = LO, $V_{DD} = 15\text{ V}$		150	225	
		IN = HI, EN = LO, $V_{DD} = 15\text{ V}$		450	650	
		IN = LO, EN = HI, $V_{DD} = 15\text{ V}$		75	125	
		IN = HI, EN = HI, $V_{DD} = 15\text{ V}$		675	1000	

enable (ENBL)

PARAMETER	TEST CONDITION	MIN	TYP	MAX	UNITS
V_{IN_H} , high-level input voltage	LO to HI transition	1.7	2.2	2.7	V
V_{IN_L} , low-level input voltage	HI to LO transition	1.1	1.6	2.0	V
Hysteresis		0.25	0.55	0.90	
R_{ENBL} , enable impedance	$V_{DD} = 14\text{ V}$, ENBL = GND	75	100	135	$\text{k}\Omega$
t_{D3} , propagation delay time ⁽⁵⁾	$C_{LOAD} = 10\text{ nF}$		60	90	ns
t_{D4} , propagation delay time ⁽⁵⁾	$C_{LOAD} = 10\text{ nF}$		60	90	

- NOTES:
1. Ensured by design. Not tested in production.
 2. The pullup / pulldown circuits of the driver are bipolar and MOSFET transistors in parallel. The peak output current rating is the combined current from the bipolar and MOSFET transistors.
 3. The pullup / pulldown circuits of the driver are bipolar and MOSFET transistors in parallel. The output resistance is the $R_{DS(ON)}$ of the MOSFET transistor when the voltage on the driver output is less than the saturation voltage of the bipolar transistor.
 5. See Figure 2.

electrical characteristics, $V_{DD} = 4.5\text{ V to }15\text{ V}$, $T_A = -40^\circ\text{C to }105^\circ\text{C}$ for UCC2732x, $T_A = 0^\circ\text{C to }70^\circ\text{C}$ for UCC3732x, $T_A = T_J$, (unless otherwise noted) (continued)

switching time (4)

PARAMETER	TEST CONDITION	MIN	TYP	MAX	UNITS
t_R , rise time (OUT)	$C_{LOAD} = 10\text{ nF}$		20	70	ns
t_F , fall time (OUT)	$C_{LOAD} = 10\text{ nF}$		20	30	
t_{D1} , propagation delay, IN rising (IN to OUT)	$C_{LOAD} = 10\text{ nF}$		25	70	
t_{D2} , propagation delay, IN falling (IN to OUT)	$C_{LOAD} = 10\text{ nF}$		35	70	

NOTES: 4. See Figure 1 for switching waveforms.

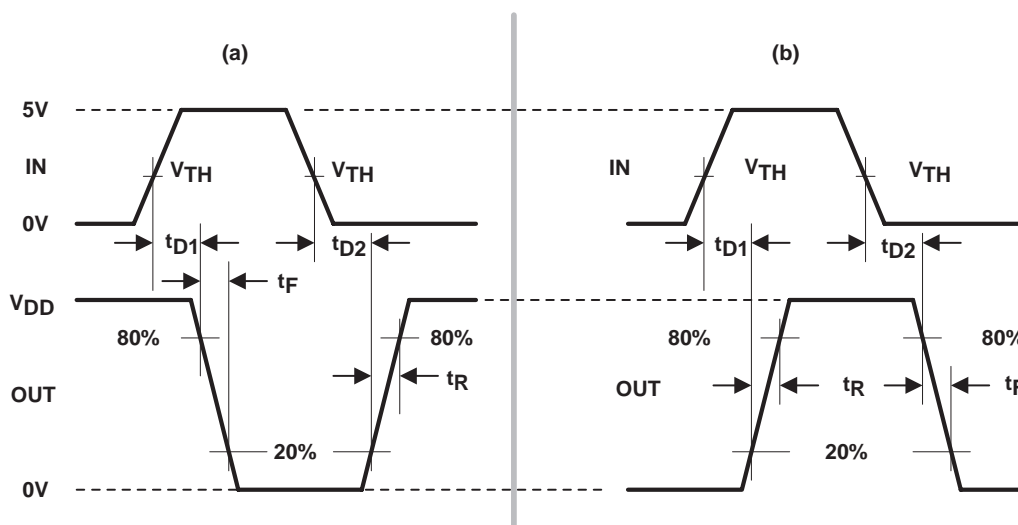

Figure 1. Switching Waveforms for (a) Inverting Input to (b) Output Times(6)

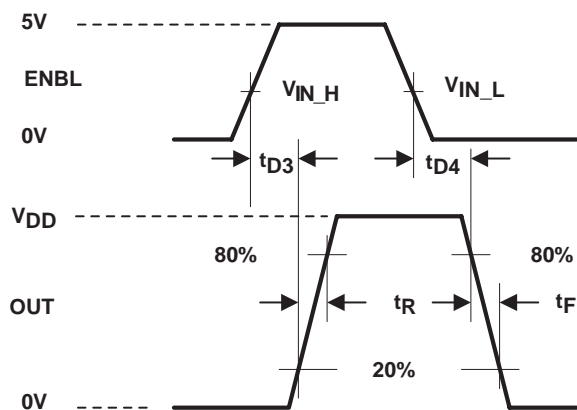
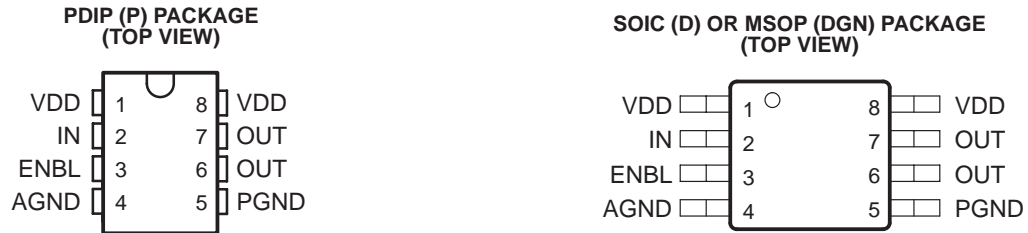

Figure 2. Switching Waveform for Enable to Output(6)

NOTES: 6. The 20% and 80% thresholds depict the dynamics of the BiPolar output devices that dominate the power MOSFET transition through the Miller regions of operation.

pin configurations



power dissipation rating table

PACKAGE	SUFFIX	θ_{jc} (°C/W)	θ_{ja} (°C/W)	Power Rating (mW) $T_A = 70^\circ\text{C}$ †	Derating Factor Above 70°C (mW/°C) †
SOIC-8	D	42	84 – 160 ‡	344–655 ‡	6.25 – 11.9 ‡
PDIP-8	P	49	110	500	9
MSOP PowerPAD-8	DGN	4.7	50–59	1370	17.1

† 125°C operating junction temperature is used for power rating calculations

‡ The range of values indicates the effect of pc-board. These values are intended to give the system designer an indication of the best and worst case conditions. In general, the system designer should attempt to use larger traces on the pc-board where possible in order to spread the heat away from the device more effectively. For additional information on device temperature management, please refer to Packaging Information section of the *Power Supply Control Products Data Book*, (Ti Literature Number SLUD003).

terminal functions

TERMINAL			FUNCTION
NO.	NAME	I/O	
4	AGND	–	Common ground for input stage. This ground should be connected very closely to the source of the power MOSFET which the driver is driving. Grounds are separated to minimize ringing affects due to output switching di/dt which can affect the input threshold.
3	ENBL	I	Enable input for the driver with logic compatible threshold and hysteresis. The driver output can be enabled and disabled with this pin. It is internally pulled up to V _{DD} with 100-kΩ resistor for active high operation. The output state when the device is disabled will be low regardless of the input state.
2	IN	I	Input signal of the driver which has logic compatible threshold and hysteresis.
6, 7	OUT	O	Driver outputs that must be connected together externally. The output stage is capable of providing 9-A peak drive current to the gate of a power MOSFET.
5	PGND	–	Common ground for output stage. This ground should be connected very closely to the source of the power MOSFET which the driver is driving. Grounds are separated to minimize ringing affects due to output switching di/dt which can affect the input threshold.
1, 8	VDD	I	Supply voltage and the power input connections for this device. Three pins must be connected together externally.

APPLICATION INFORMATION

general information

The UCC37321 and UCC37322 drivers serve as an interface between low-power controllers and power MOSFETs. They can also be used as an interface between DSPs and power MOSFETs. High-frequency power supplies often require high-speed, high-current drivers such as the UCC37321/2 family. A leading application is the need to provide a high power buffer stage between the PWM output of the control device and the gates of the primary power MOSFET or IGBT switching devices. In other cases, the device drives the power device gates through a drive transformer. Synchronous rectification supplies also have the need to simultaneously drive multiple devices which can present an extremely large load to the control circuitry.

The inverting driver (UCC37321) is useful for generating inverted gate drive signals from controllers that have only outputs of the opposite polarity. For example, this driver can provide a gate signal for ground referenced, N-channel synchronous rectifier MOSFETs in buck derived converters. This driver can also be used for generating a gate drive signal for a P-channel MOSFET from a controller that is designed for N-channel applications.

MOSFET gate drivers are generally used when it is not feasible to have the primary PWM regulator device directly drive the switching devices for one or more reasons. The PWM device may not have the brute drive capability required for the intended switching MOSFET, limiting the switching performance in the application. In other cases there may be a desire to minimize the effect of high frequency switching noise by placing the high current driver physically close to the load. Also, newer devices that target the highest operating frequencies may not incorporate onboard gate drivers at all. Their PWM outputs are only intended to drive the high impedance input to a driver such as the UCC37321/2. Finally, the control device may be under thermal stress due to power dissipation, and an external driver can help by moving the heat from the controller to an external package.

input stage

The IN threshold has a 3.3-V logic sensitivity over the full range of V_{DD} voltages; yet, it is equally compatible with 0 V to V_{DD} signals. The inputs of UCC37321/2 family of drivers are designed to withstand 500-mA reverse current without either damage to the device or logic upset. In addition, the input threshold turn-off of the UCC37321/2 has been slightly raised for improved noise immunity. The input stage of each driver should be driven by a signal with a short rise or fall time. This condition is satisfied in typical power supply applications, where the input signals are provided by a PWM controller or logic gates with fast transition times (<200 ns). The IN input of the driver functions as a digital gate, and it is not intended for applications where a slow changing input voltage is used to generate a switching output when the logic threshold of the input section is reached. While this may not be harmful to the driver, the output of the driver may switch repeatedly at a high frequency.

Users should not attempt to shape the input signals to the driver in an attempt to slow down (or delay) the signal at the output. If limiting the rise or fall times to the power device is desired, then an external resistance can be added between the output of the driver and the load device, which is generally a power MOSFET gate. The external resistor may also help remove power dissipation from the device package, as discussed in the section on Thermal Considerations.

APPLICATION INFORMATION

output stage

The TrueDrive output stage is capable of supplying $\pm 9\text{-A}$ peak current pulses and swings to both VDD and GND and can encourage even the most stubborn MOSFETs to switch. The pull-up/pull-down circuits of the driver are constructed of bipolar and MOSFET transistors in parallel. The peak output current rating is the combined current from the bipolar and MOSFET transistors. The output resistance is the $R_{DS(ON)}$ of the MOSFET transistor when the voltage on the driver output is less than the saturation voltage of the bipolar transistor. Each output stage also provides a very low impedance to overshoot and undershoot due to the body diode of the external MOSFET. This means that in many cases, external-schottky-clamp diodes are not required.

This unique BiPolar and MOSFET hybrid output architecture (TrueDrive) allows efficient current sourcing at low supply voltages. The UCC37321/2 family delivers 9 A of gate drive where it is most needed during the MOSFET switching transition – at the Miller plateau region – providing improved efficiency gains.

source/sink capabilities during miller plateau

Large power MOSFETs present a significant load to the control circuitry. Proper drive is required for efficient, reliable operation. The UCC37321/2 drivers have been optimized to provide maximum drive to a power MOSFET during the Miller Plateau Region of the switching transition. This interval occurs while the drain voltage is swinging between the voltage levels dictated by the power topology, requiring the charging/discharging of the drain-gate capacitance with current supplied or removed by the driver device. [1]

Two circuits are used to test the current capabilities of the UCC37321/2 driver. In each case external circuitry is added to clamp the output near 5 V while the device is sinking or sourcing current. An input pulse of 250 ns is applied at a frequency of 1 kHz in the proper polarity for the respective test. In each test there is a transient period where the current peaked up and then settled down to a steady-state value. The noted current measurements are made at a time of 200 ns after the input pulse is applied, after the initial transient.

The circuit in Figure 3 is used to verify the current sink capability when the output of the driver is clamped around 5 V, a typical value of gate-source voltage during the Miller Plateau Region. The UCC37321 is found to sink 9 A at $V_{DD} = 15\text{ V}$.

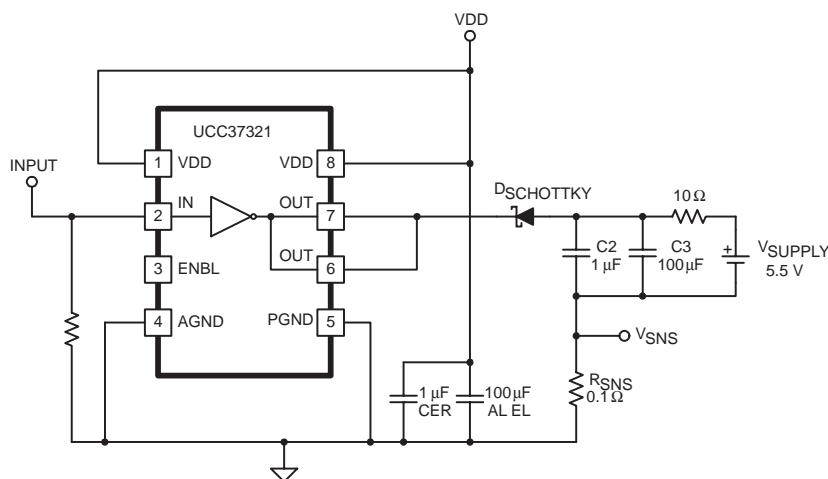

UDG-01113

Figure 3. Sink Current Test Circuit

APPLICATION INFORMATION

The circuit in Figure 4 is utilized to test the current source capability with the output clamped to around 5 V with a string of Zener diodes. The UCC37321 is found to source 9 A at $V_{DD} = 15$ V.

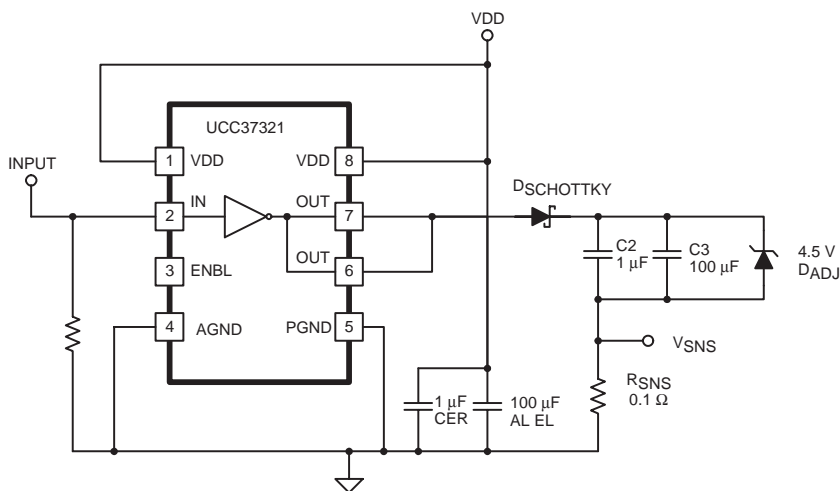

UDG-01114

Figure 4. Source Current Test Circuit

It should be noted that the current sink capability is slightly stronger than the current source capability at lower VDD. This is due to the differences in the structure of the bipolar-MOSFET power output section, where the current source is a P-channel MOSFET and the current sink has an N-channel MOSFET.

In a large majority of applications it is advantageous that the turn-off capability of a driver is stronger than the turn-on capability. This helps to ensure that the MOSFET is held OFF during common power supply transients which may turn the device back ON.

operational circuit layout

It can be a significant challenge to avoid the overshoot/undershoot and ringing issues that can arise from circuit layout. The low impedance of these drivers and their high di/dt can induce ringing between parasitic inductances and capacitances in the circuit. Utmost care must be used in the circuit layout.

In general, position the driver physically as close to its load as possible. Place a 1- μ F bypass capacitor as close to the output side of the driver as possible, connecting it to pins 1 and 8. Connect a single trace between the two VDD pins (pin 1 and pin 8); connect a single trace between PGND and AGND (pin 5 and pin 4). If a ground plane is used, it may be connected to AGND; do not extend the plane beneath the output side of the package (pins 5 – 8). Connect the load to both OUT pins (pins 7 and 6) with a single trace on the adjacent layer to the component layer; route the return current path for the output on the component side, directly over the output path.

Extreme conditions may require decoupling the input power and ground connections from the output power and ground connections. The UCCx7321/2 has a feature that allows the user to take these extreme measures, if necessary. There is a small amount of internal impedance of about 15 Ω between the AGND and PGND pins; there is also a small amount of impedance (~30 Ω) between the two VDD pins. In order to take advantage of this feature, connect a 1- μ F bypass capacitor between VDD and PGND (pins 5 and 8) and connect a 0.1- μ F bypass capacitor between VDD and AGND (pins 1 and 4). Further decoupling can be achieved by connecting between the two VDD pins with a jumper that passes through a 40-MHz ferrite bead and connect bias power only to pin 8. Even more decoupling can be achieved by connecting between AGND and PGND with a pair of anti-parallel diodes (anode connected to cathode and cathode connected to anode).

APPLICATION INFORMATION

VDD

Although quiescent VDD current is very low, total supply current will be higher, depending on OUTA and OUTB current and the operating frequency. Total VDD current is the sum of quiescent VDD current and the average OUT current. Knowing the operating frequency and the MOSFET gate charge (Qg), average OUT current can be calculated from:

$$I_{OUT} = Qg \times f, \text{ where } f \text{ is frequency}$$

For the best high-speed circuit performance, two V_{DD} bypass capacitors are recommended to prevent noise problems. The use of surface mount components is highly recommended. A 0.1-μF ceramic capacitor should be located closest to the VDD to ground connection. In addition, a larger capacitor (such as 1-μF) with relatively low ESR should be connected in parallel, to help deliver the high current peaks to the load. The parallel combination of capacitors should present a low impedance characteristic for the expected current levels in the driver application.

drive current and power requirements

The UCC37321/2 family of drivers are capable of delivering 9-A of current to a MOSFET gate for a period of several hundred nanoseconds. High peak current is required to turn an N-channel device ON quickly. Then, to turn the device OFF, the driver is required to sink a similar amount of current to ground. This repeats at the operating frequency of the power device. An N-channel MOSFET is used in this discussion because it is the most common type of switching device used in high frequency power conversion equipment.

References 1 and 2 contain detailed discussions of the drive current required to drive a power MOSFET and other capacitive-input switching devices. Much information is provided in tabular form to give a range of the current required for various devices at various frequencies. The information pertinent to calculating gate drive current requirements will be summarized here; the original document is available from the TI website.

When a driver device is tested with a discrete, capacitive load it is a fairly simple matter to calculate the power that is required from the bias supply. The energy that must be transferred from the bias supply to charge the capacitor is given by:

$$E = \frac{1}{2}CV^2, \text{ where } C \text{ is the load capacitor and } V \text{ is the bias voltage feeding the driver.}$$

There is an equal amount of energy transferred to ground when the capacitor is discharged. This leads to a power loss given by the following:

$$P = 2 \times \frac{1}{2}CV^2f, \text{ where } f \text{ is the switching frequency.}$$

This power is dissipated in the resistive elements of the circuit. Thus, with no external resistor between the driver and gate, this power is dissipated inside the driver. Half of the total power is dissipated when the capacitor is charged, and the other half is dissipated when the capacitor is discharged. An actual example using the conditions of the previous gate drive waveform should help clarify this.

With V_{DD} = 12 V, C_{LOAD} = 10 nF, and f = 300 kHz, the power loss can be calculated as:

$$P = 10 \text{ nF} \times (12)^2 \times (300 \text{ kHz}) = 0.432 \text{ W}$$

With a 12-V supply, this would equate to a current of:

$$I = \frac{P}{V} = \frac{0.432 \text{ W}}{12 \text{ V}} = 0.036 \text{ A}$$

APPLICATION INFORMATION

drive current and power requirements (continued)

The switching load presented by a power MOSFET can be converted to an equivalent capacitance by examining the gate charge required to switch the device. This gate charge includes the effects of the input capacitance plus the added charge needed to swing the drain of the device between the ON and OFF states. Most manufacturers provide specifications that provide the typical and maximum gate charge, in nC, to switch the device under specified conditions. Using the gate charge Q_g, one can determine the power that must be dissipated when charging a capacitor. This is done by using the equivalence Q_g = C_{eff}V to provide the following equation for power:

$$P = C \times V^2 \times f = Q_g \times V \times f$$

This equation allows a power designer to calculate the bias power required to drive a specific MOSFET gate at a specific bias voltage.

enable

UCC37321/2 provides an Enable input for improved control of the driver operation. This input also incorporates logic compatible thresholds with hysteresis. It is internally pulled up to V_{DD} with 100-kΩ resistor for active high operation. When ENBL is high, the device is enabled and when ENBL is low, the device is disabled. The default state of the ENBL pin is to enable the device and therefore can be left open for standard operation. The output state when the device is disabled is low regardless of the input state. See the truth table below for the operation using enable logic.

ENBL input is compatible with both logic signals and slow changing analog signals. It can be directly driven or a power-up delay can be programmed with a capacitor between ENBL and AGND.

Table 1. Input/Output Table

	ENBL	IN	OUT
INVERTING UCC37321	0	0	0
	0	1	0
	1	0	1
	1	1	0
NON- INVERTING UCC37322	0	0	0
	0	1	0
	1	0	0
	1	1	1

THERMAL INFORMATION

The useful range of a driver is greatly affected by the drive power requirements of the load and the thermal characteristics of the device package. In order for a power driver to be useful over a particular temperature range the package must allow for the efficient removal of the heat produced while keeping the junction temperature within rated limits. The UCC37321/2 family of drivers is available in three different packages to cover a range of application requirements.

As shown in the power dissipation rating table, the SOIC-8 (D) and PDIP-8 (P) packages each have a power rating of around 0.5 W with $T_A = 70^\circ\text{C}$. This limit is imposed in conjunction with the power derating factor also given in the table. Note that the power dissipation in our earlier example is 0.432 W with a 10-nF load, 12 VDD, switched at 300 kHz. Thus, only one load of this size could be driven using the D or P package. The difficulties with heat removal limit the drive available in the D or P packages.

The MSOP PowerPAD-8 (DGN) package significantly relieves this concern by offering an effective means of removing the heat from the semiconductor junction. As illustrated in Reference 3, the PowerPAD packages offer a leadframe die pad that is exposed at the base of the package. This pad is soldered to the copper on the PC board directly underneath the device package, reducing the θ_{jc} down to 4.7°C/W . Data is presented in Reference 3 to show that the power dissipation can be quadrupled in the PowerPAD configuration when compared to the standard packages. The PC board must be designed with thermal lands and thermal vias to complete the heat removal subsystem, as summarized in Reference 4. This allows a significant improvement in heatsinking over that available in the D or P packages, and is shown to more than double the power capability of the D and P packages.

Note that the PowerPAD™ is not directly connected to any leads of the package. However, it is electrically and thermally connected to the substrate which is the ground of the device.

references

1. SEM-1400, Topic 2, *A Design and Application Guide for High Speed Power MOSFET Gate Drive Circuits*, TI Literature No. SLUP133
2. U-137, *Practical Considerations in High Performance MOSFET, IGBT and MCT Gate Drive Circuits*, by Bill Andreyckak, TI Literature No. SLUA105
3. Technical Brief, *PowerPad Thermally Enhanced Package*, TI Literature No. SLMA002
4. Application Brief, *PowerPAD Made Easy*, TI Literature No. SLMA004

related products

PRODUCT	DESCRIPTION	PACKAGES
UCC37323/4/5	Dual 4-A Low-Side Drivers	MSOP-8 PowerPAD, SOIC-8, PDIP-8
UCC27423/4/5	Dual 4-A Low-Side Drivers with Enable	MSOP-8 PowerPAD, SOIC-8, PDIP-8
TPS2811/12/13	Dual 2-A Low-Side Drivers with Internal Regulator	TSSOP-8, SOIC-8, PDIP-8
TPS2814/15	Dual 2-A Low-Side Drivers with Two Inputs per Channel	TSSOP-8, SOIC-8, PDIP-8
TPS2816/17/18/19	Single 2-A Low-Side Driver with Internal Regulator	5-Pin SOT-23
TPS2828/29	Single 2-A Low-Side Driver	5-Pin SOT-23

TYPICAL CHARACTERISTICS

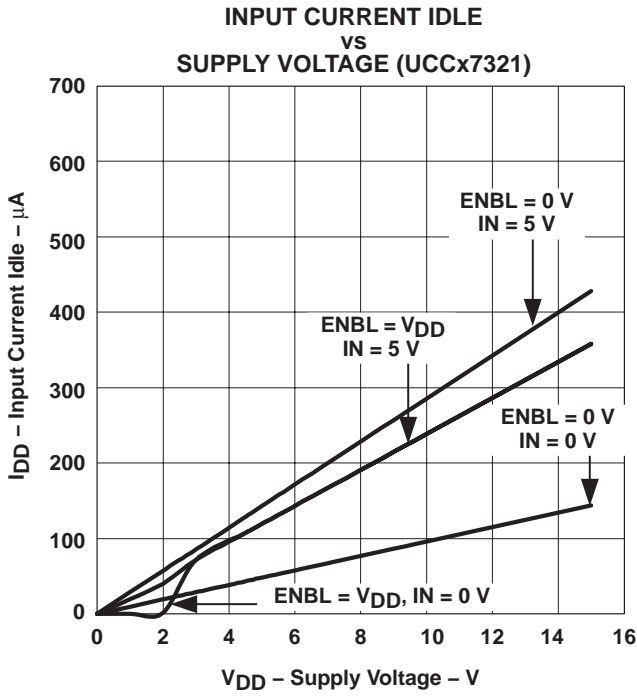

Figure 5

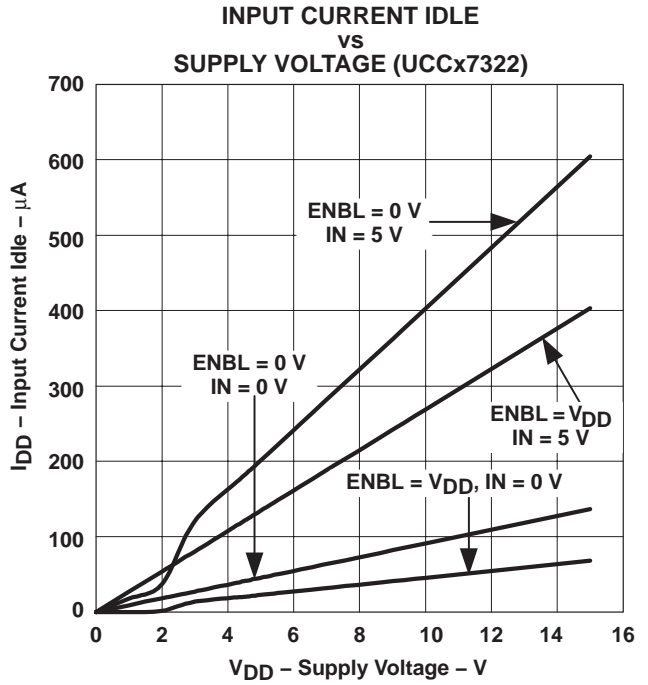

Figure 6

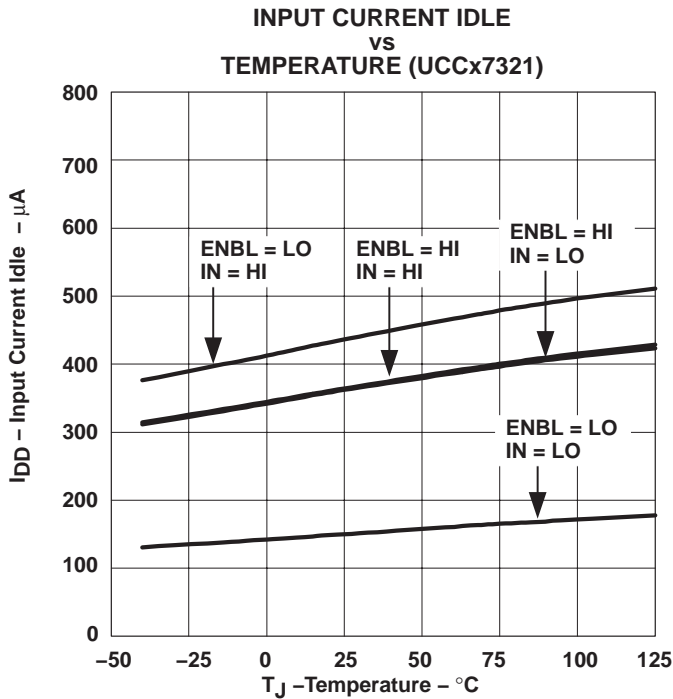

Figure 7

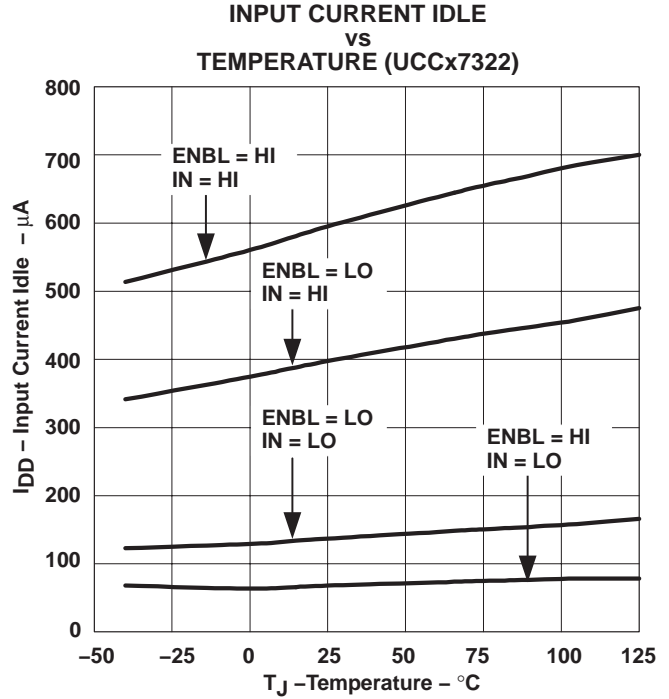

Figure 8

TYPICAL CHARACTERISTICS

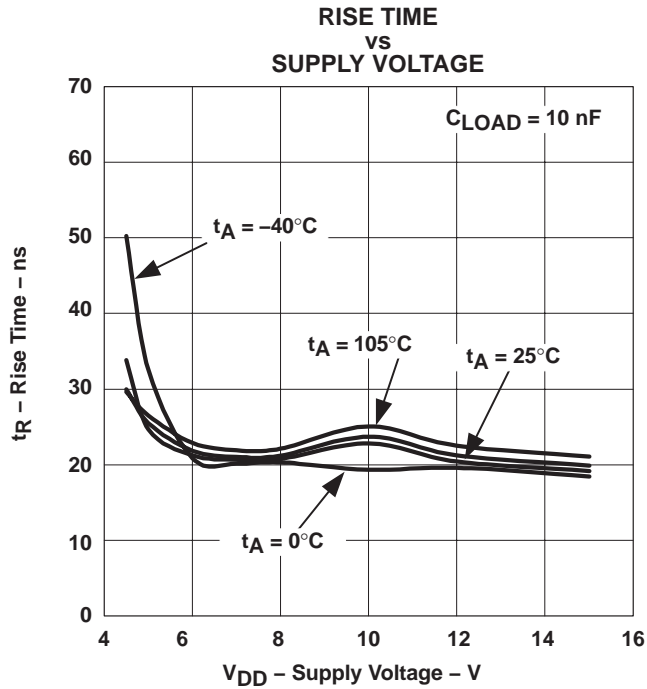

Figure 9

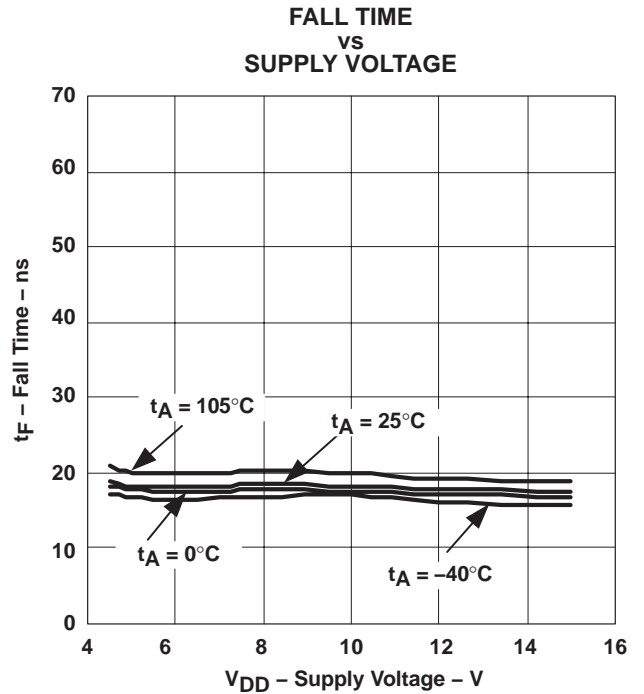

Figure 10

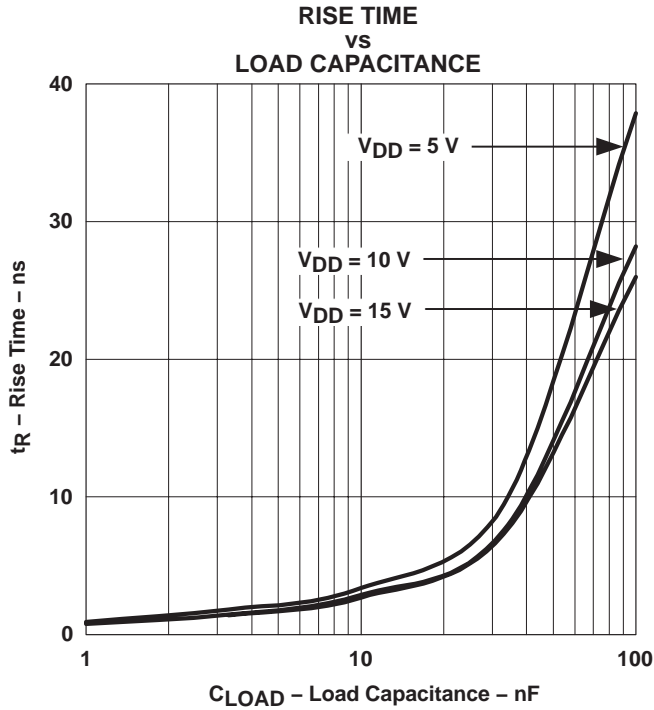

Figure 11

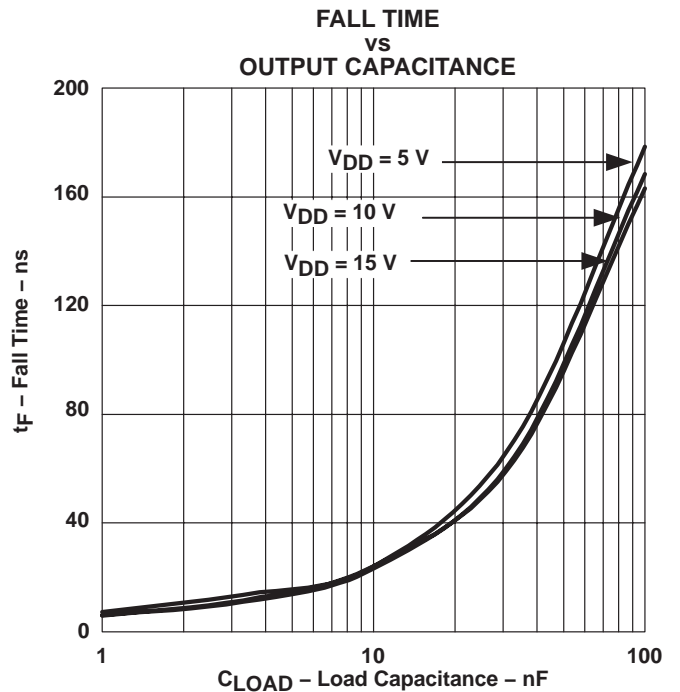

Figure 12

TYPICAL CHARACTERISTICS

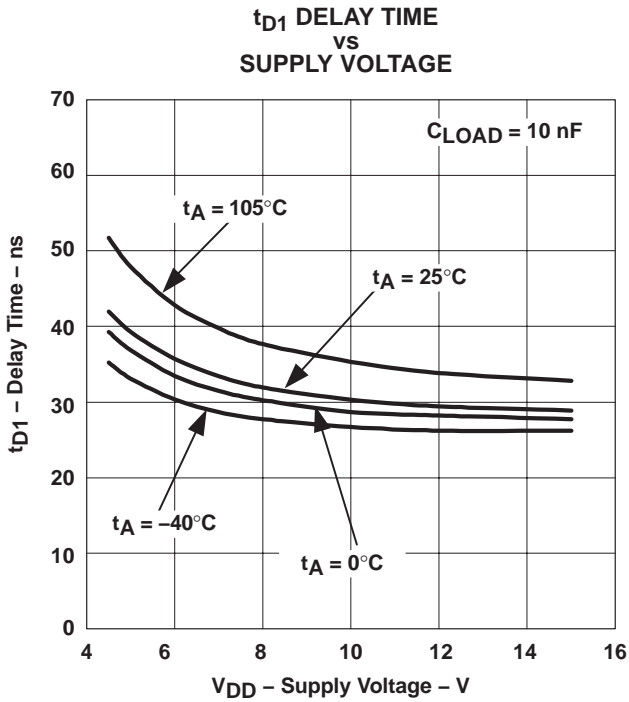

Figure 13

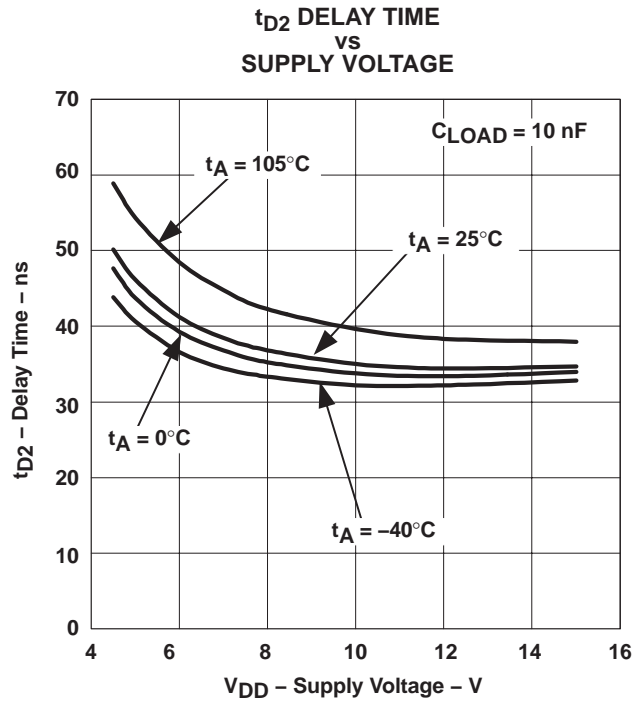

Figure 14

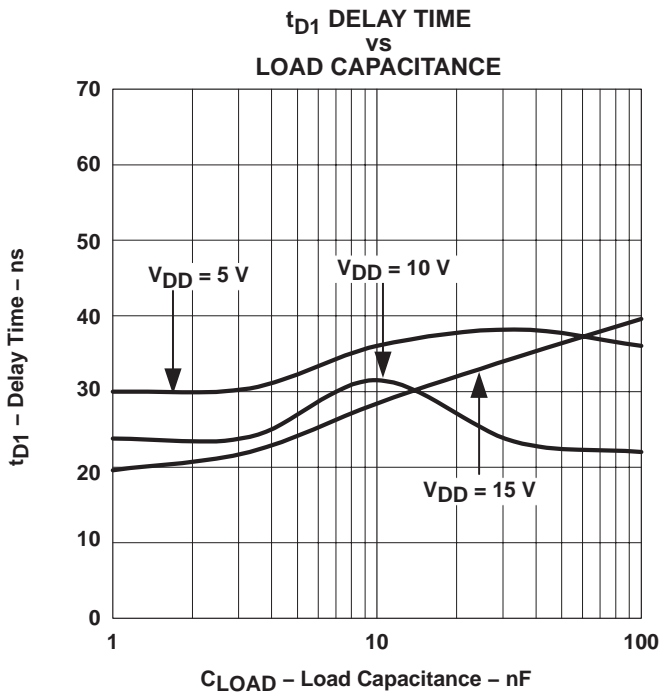

Figure 15

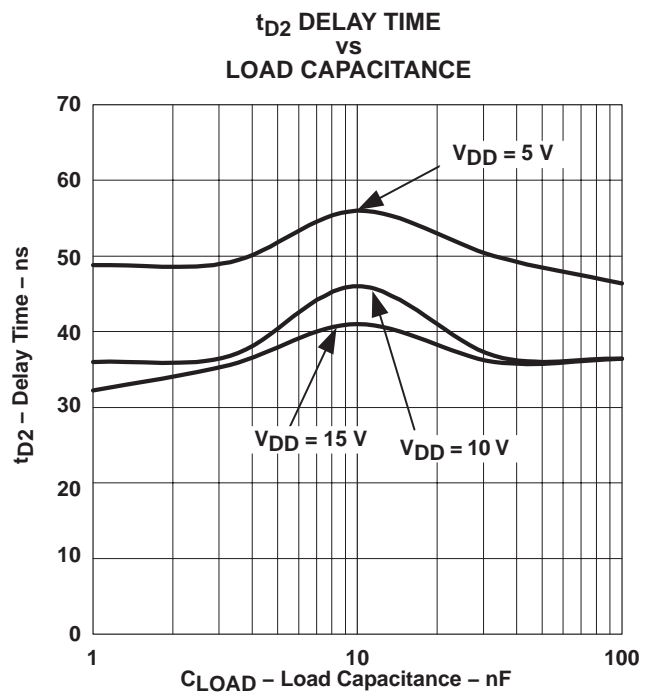

Figure 16

TYPICAL CHARACTERISTICS

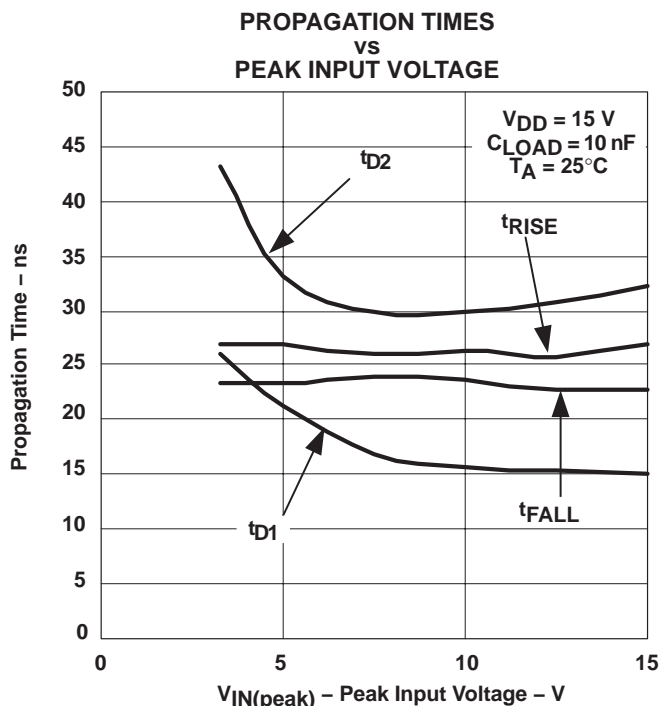

Figure 17

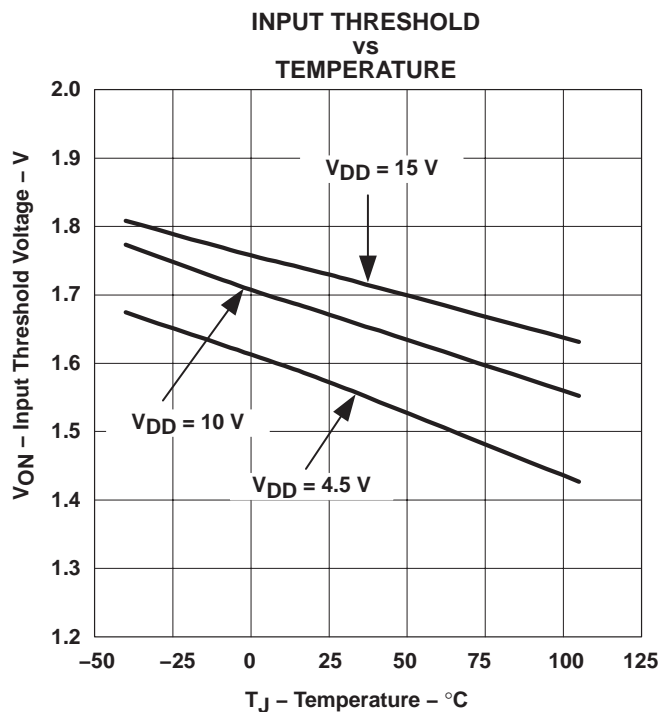

Figure 18

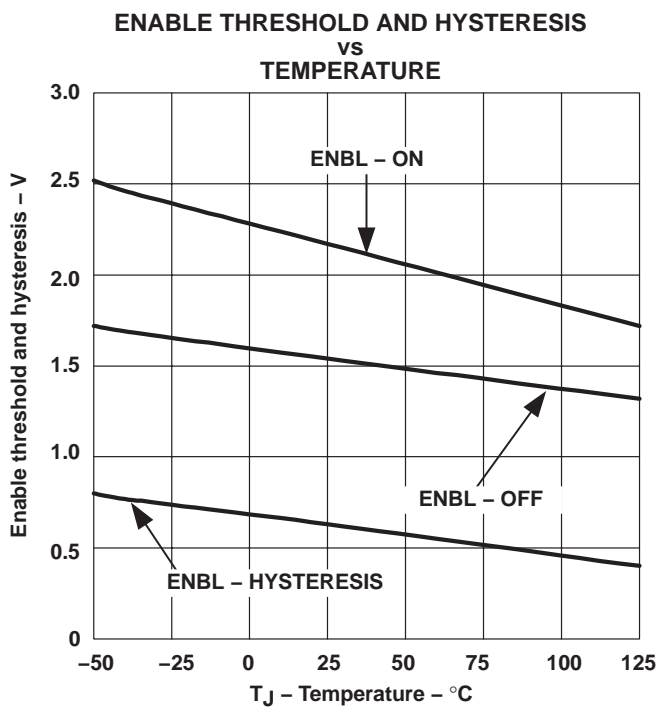

Figure 19

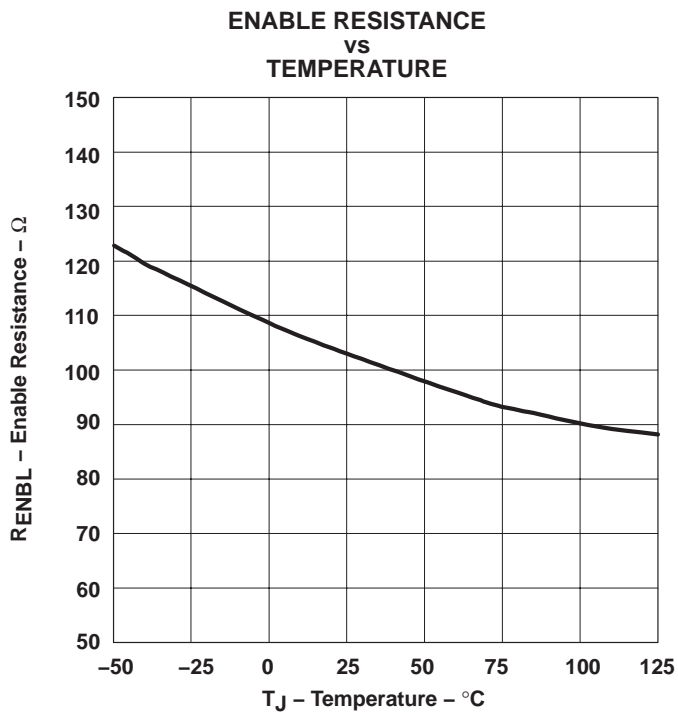

Figure 20

TYPICAL CHARACTERISTICS

OUTPUT BEHAVIOR
 vs
 V_{DD} (UCC37321)

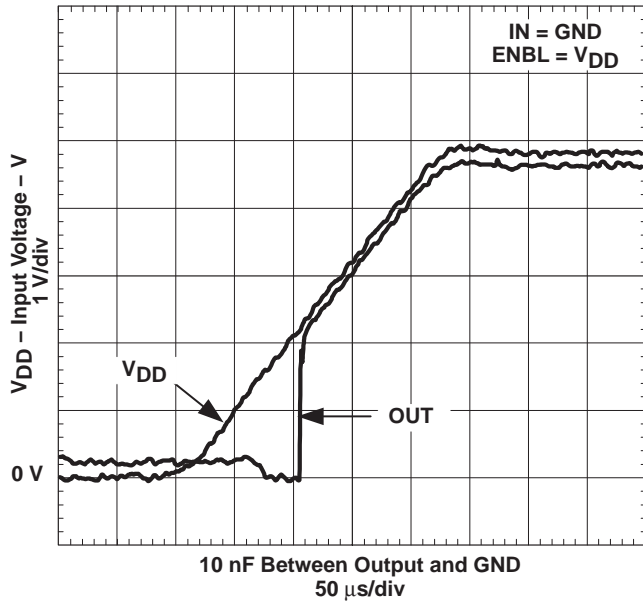

Figure 21

OUTPUT BEHAVIOR
 vs
 V_{DD} (UCC37321)

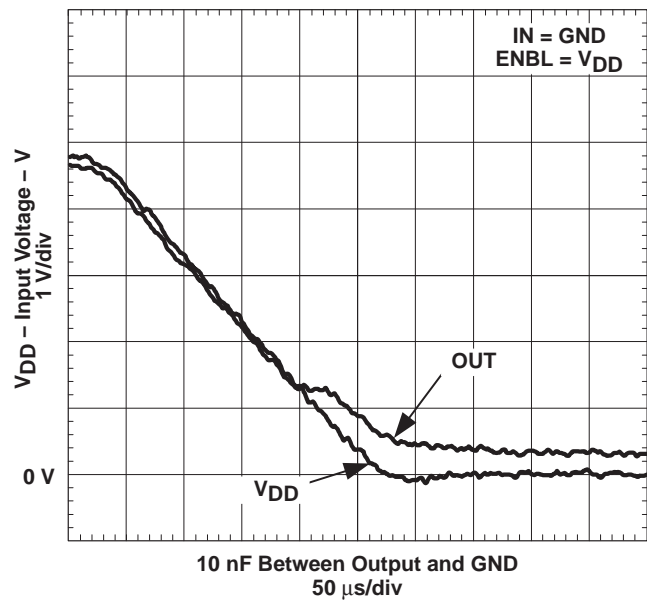

Figure 22

OUTPUT BEHAVIOR
 vs
 V_{DD} (INVERTING)

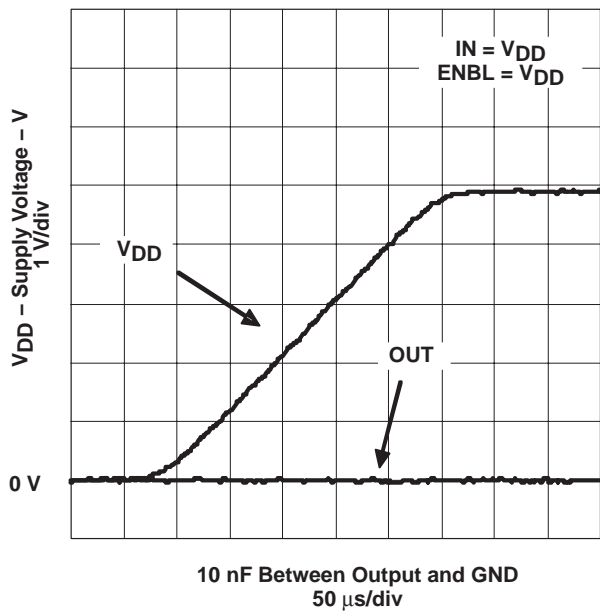

Figure 23

OUTPUT BEHAVIOR
 vs
 V_{DD} (INVERTING)

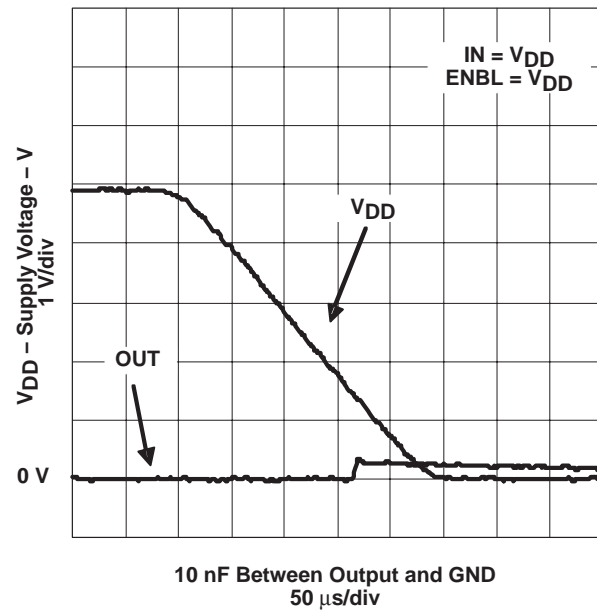
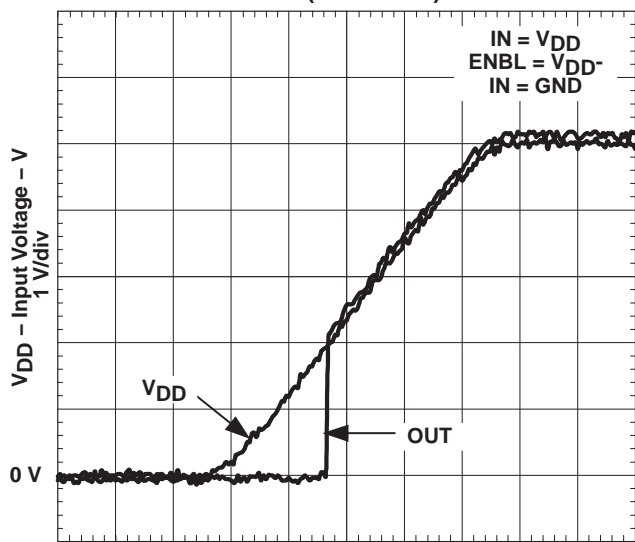

Figure 24

TYPICAL CHARACTERISTICS

OUTPUT BEHAVIOR
vs
VDD (UCC37322)



10 nF Between Output and GND
50 μs/div

Figure 25

OUTPUT BEHAVIOR
vs
VDD (UCC37322)

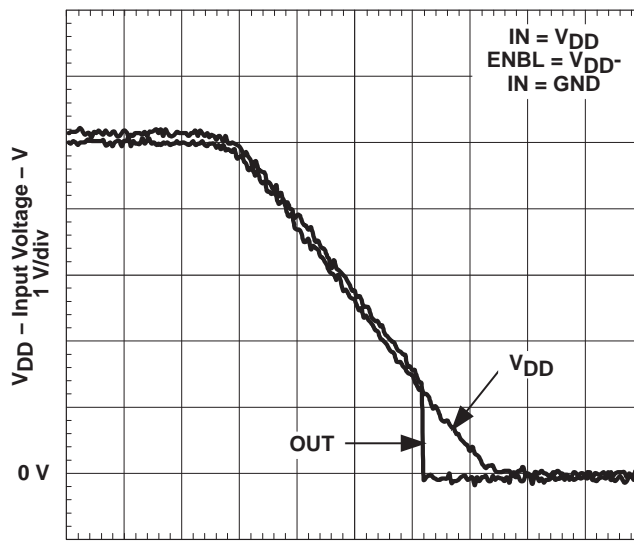

10 nF Between Output and GND
50 μs/div

Figure 26

OUTPUT BEHAVIOR
vs
VDD (NON-INVERTING)

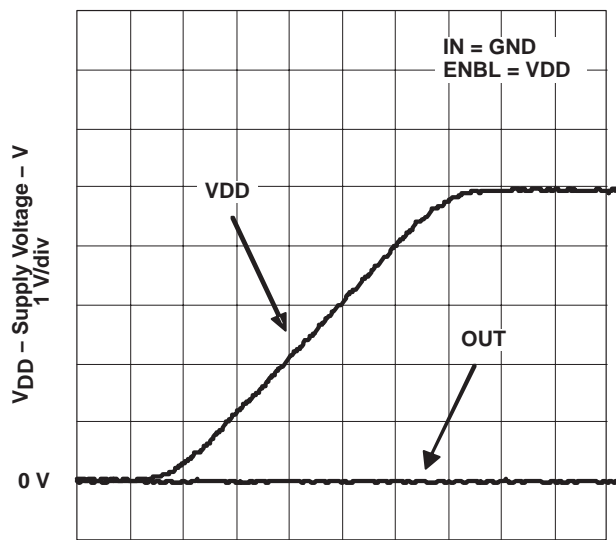

10 nF Between Output and GND
50 μs/div

Figure 27

OUTPUT BEHAVIOR
vs
VDD (NON-INVERTING)

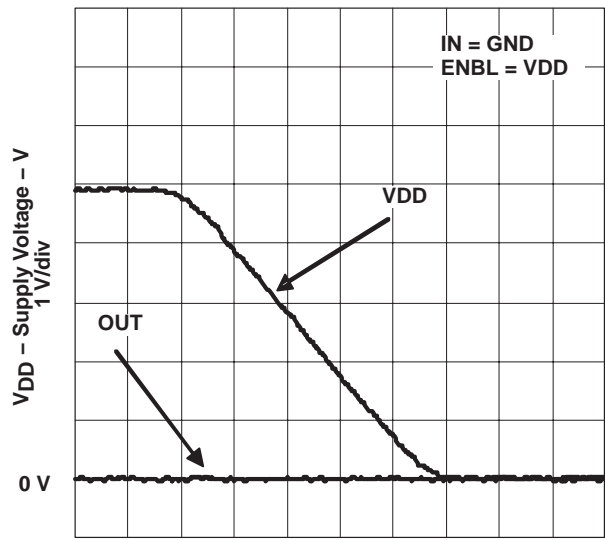

10 nF Between Output and GND
50 μs/div

Figure 28

PACKAGING INFORMATION

Orderable Device	Status ⁽¹⁾	Package Type	Package Drawing	Pins	Package Qty	Eco Plan ⁽²⁾	Lead/Ball Finish	MSL Peak Temp ⁽³⁾
UCC27321D	ACTIVE	SOIC	D	8	75	Green (RoHS & no Sb/Br)	CU NIPDAU	Level-1-260C-UNLIM
UCC27321DGN	ACTIVE	MSOP-Power PAD	DGN	8	80	Green (RoHS & no Sb/Br)	CU NIPDAU	Level-1-260C-UNLIM
UCC27321DGNG4	ACTIVE	MSOP-Power PAD	DGN	8	80	Green (RoHS & no Sb/Br)	CU NIPDAU	Level-1-260C-UNLIM
UCC27321DGNR	ACTIVE	MSOP-Power PAD	DGN	8	2500	Green (RoHS & no Sb/Br)	CU NIPDAU	Level-1-260C-UNLIM
UCC27321DGNRG4	ACTIVE	MSOP-Power PAD	DGN	8	2500	Green (RoHS & no Sb/Br)	CU NIPDAU	Level-1-260C-UNLIM
UCC27321DR	ACTIVE	SOIC	D	8	2500	Green (RoHS & no Sb/Br)	CU NIPDAU	Level-1-260C-UNLIM
UCC27321DRG4	ACTIVE	SOIC	D	8	2500	Green (RoHS & no Sb/Br)	CU NIPDAU	Level-1-260C-UNLIM
UCC27321P	ACTIVE	PDIP	P	8	50	Pb-Free (RoHS)	CU NIPDAU	N / A for Pkg Type
UCC27321PE4	ACTIVE	PDIP	P	8	50	Pb-Free (RoHS)	CU NIPDAU	N / A for Pkg Type
UCC27322D	ACTIVE	SOIC	D	8	75	Green (RoHS & no Sb/Br)	CU NIPDAU	Level-1-260C-UNLIM
UCC27322DG4	ACTIVE	SOIC	D	8	75	Green (RoHS & no Sb/Br)	CU NIPDAU	Level-1-260C-UNLIM
UCC27322DGN	ACTIVE	MSOP-Power PAD	DGN	8	80	Green (RoHS & no Sb/Br)	CU NIPDAU	Level-1-260C-UNLIM
UCC27322DGNG4	ACTIVE	MSOP-Power PAD	DGN	8	80	Green (RoHS & no Sb/Br)	CU NIPDAU	Level-1-260C-UNLIM
UCC27322DGNR	ACTIVE	MSOP-Power PAD	DGN	8	2500	Green (RoHS & no Sb/Br)	CU NIPDAU	Level-1-260C-UNLIM
UCC27322DGNRG4	ACTIVE	MSOP-Power PAD	DGN	8	2500	Green (RoHS & no Sb/Br)	CU NIPDAU	Level-1-260C-UNLIM
UCC27322DR	ACTIVE	SOIC	D	8	2500	Green (RoHS & no Sb/Br)	CU NIPDAU	Level-1-260C-UNLIM
UCC27322DRG4	ACTIVE	SOIC	D	8	2500	Green (RoHS & no Sb/Br)	CU NIPDAU	Level-1-260C-UNLIM
UCC27322P	ACTIVE	PDIP	P	8	50	Pb-Free (RoHS)	CU NIPDAU	N / A for Pkg Type
UCC27322PE4	ACTIVE	PDIP	P	8	50	Pb-Free (RoHS)	CU NIPDAU	N / A for Pkg Type
UCC37321D	ACTIVE	SOIC	D	8	75	Green (RoHS & no Sb/Br)	CU NIPDAU	Level-1-260C-UNLIM
UCC37321DGN	ACTIVE	MSOP-Power PAD	DGN	8	80	Green (RoHS & no Sb/Br)	CU NIPDAU	Level-1-260C-UNLIM

Orderable Device	Status ⁽¹⁾	Package Type	Package Drawing	Pins	Package Qty	Eco Plan ⁽²⁾	Lead/Ball Finish	MSL Peak Temp ⁽³⁾
UCC37321DGNG4	ACTIVE	MSOP-Power PAD	DGN	8	80	Green (RoHS & no Sb/Br)	CU NIPDAU	Level-1-260C-UNLIM
UCC37321DGNR	ACTIVE	MSOP-Power PAD	DGN	8	2500	Green (RoHS & no Sb/Br)	CU NIPDAU	Level-1-260C-UNLIM
UCC37321DGNRG4	ACTIVE	MSOP-Power PAD	DGN	8	2500	Green (RoHS & no Sb/Br)	CU NIPDAU	Level-1-260C-UNLIM
UCC37321DR	ACTIVE	SOIC	D	8	2500	Green (RoHS & no Sb/Br)	CU NIPDAU	Level-1-260C-UNLIM
UCC37321DRG4	ACTIVE	SOIC	D	8	2500	Green (RoHS & no Sb/Br)	CU NIPDAU	Level-2-260C-1 YEAR
UCC37321P	ACTIVE	PDIP	P	8	50	Pb-Free (RoHS)	CU NIPDAU	N / A for Pkg Type
UCC37321PE4	ACTIVE	PDIP	P	8	50	Pb-Free (RoHS)	CU NIPDAU	N / A for Pkg Type
UCC37322D	ACTIVE	SOIC	D	8	75	Green (RoHS & no Sb/Br)	CU NIPDAU	Level-1-260C-UNLIM
UCC37322DGN	ACTIVE	MSOP-Power PAD	DGN	8	80	Green (RoHS & no Sb/Br)	CU NIPDAU	Level-1-260C-UNLIM
UCC37322DGNG4	ACTIVE	MSOP-Power PAD	DGN	8	80	Green (RoHS & no Sb/Br)	CU NIPDAU	Level-1-260C-UNLIM
UCC37322DGNR	ACTIVE	MSOP-Power PAD	DGN	8	2500	Green (RoHS & no Sb/Br)	CU NIPDAU	Level-1-260C-UNLIM
UCC37322DGNRG4	ACTIVE	MSOP-Power PAD	DGN	8	2500	Green (RoHS & no Sb/Br)	CU NIPDAU	Level-1-260C-UNLIM
UCC37322DR	ACTIVE	SOIC	D	8	2500	Green (RoHS & no Sb/Br)	CU NIPDAU	Level-1-260C-UNLIM
UCC37322DRG4	ACTIVE	SOIC	D	8	2500	Green (RoHS & no Sb/Br)	CU NIPDAU	Level-1-260C-UNLIM
UCC37322P	ACTIVE	PDIP	P	8	50	Pb-Free (RoHS)	CU NIPDAU	N / A for Pkg Type
UCC37322PE4	ACTIVE	PDIP	P	8	50	Pb-Free (RoHS)	CU NIPDAU	N / A for Pkg Type

⁽¹⁾ The marketing status values are defined as follows:

ACTIVE: Product device recommended for new designs.

LIFEBUY: TI has announced that the device will be discontinued, and a lifetime-buy period is in effect.

NRND: Not recommended for new designs. Device is in production to support existing customers, but TI does not recommend using this part in a new design.

PREVIEW: Device has been announced but is not in production. Samples may or may not be available.

OBsolete: TI has discontinued the production of the device.

⁽²⁾ Eco Plan - The planned eco-friendly classification: Pb-Free (RoHS), Pb-Free (RoHS Exempt), or Green (RoHS & no Sb/Br) - please check <http://www.ti.com/productcontent> for the latest availability information and additional product content details.

TBD: The Pb-Free/Green conversion plan has not been defined.

Pb-Free (RoHS): TI's terms "Lead-Free" or "Pb-Free" mean semiconductor products that are compatible with the current RoHS requirements for all 6 substances, including the requirement that lead not exceed 0.1% by weight in homogeneous materials. Where designed to be soldered at high temperatures, TI Pb-Free products are suitable for use in specified lead-free processes.

Pb-Free (RoHS Exempt): This component has a RoHS exemption for either 1) lead-based flip-chip solder bumps used between the die and

package, or 2) lead-based die adhesive used between the die and leadframe. The component is otherwise considered Pb-Free (RoHS compatible) as defined above.

Green (RoHS & no Sb/Br): TI defines "Green" to mean Pb-Free (RoHS compatible), and free of Bromine (Br) and Antimony (Sb) based flame retardants (Br or Sb do not exceed 0.1% by weight in homogeneous material)

⁽³⁾ MSL, Peak Temp. -- The Moisture Sensitivity Level rating according to the JEDEC industry standard classifications, and peak solder temperature.

Important Information and Disclaimer:The information provided on this page represents TI's knowledge and belief as of the date that it is provided. TI bases its knowledge and belief on information provided by third parties, and makes no representation or warranty as to the accuracy of such information. Efforts are underway to better integrate information from third parties. TI has taken and continues to take reasonable steps to provide representative and accurate information but may not have conducted destructive testing or chemical analysis on incoming materials and chemicals. TI and TI suppliers consider certain information to be proprietary, and thus CAS numbers and other limited information may not be available for release.

In no event shall TI's liability arising out of such information exceed the total purchase price of the TI part(s) at issue in this document sold by TI to Customer on an annual basis.

P (R-PDIP-T8)

PLASTIC DUAL-IN-LINE



- NOTES: A. All linear dimensions are in inches (millimeters).
 B. This drawing is subject to change without notice.
 C. Falls within JEDEC MS-001

For the latest package information, go to http://www.ti.com/sc/docs/package/pkg_info.htm

MECHANICAL DATA

DGN (S-PDSO-G8)

PowerPAD™ PLASTIC SMALL-OUTLINE PACKAGE

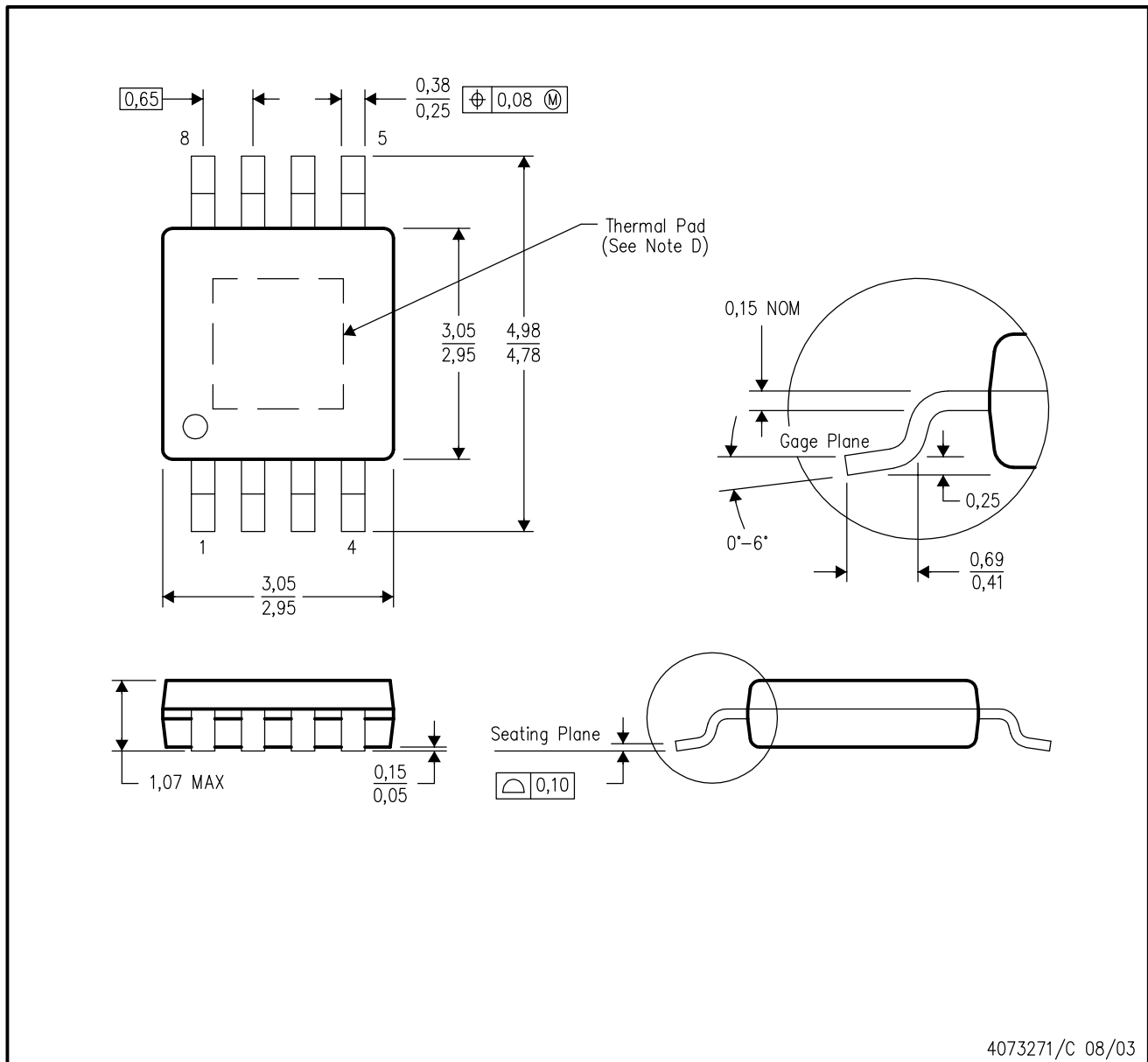

4073271/C 08/03

- NOTES:
- All linear dimensions are in millimeters.
 - This drawing is subject to change without notice.
 - Body dimensions do not include mold flash or protrusion.
 - This package is designed to be soldered to a thermal pad on the board. Refer to Technical Brief, PowerPad Thermally Enhanced Package, Texas Instruments Literature No. SLMA002 for information regarding recommended board layout. This document is available at www.ti.com <<http://www.ti.com>>.
 - Falls within JEDEC MO-187

PowerPAD is a trademark of Texas Instruments.

D (R-PDSO-G8)

PLASTIC SMALL-OUTLINE PACKAGE



- NOTES:
- A. All linear dimensions are in inches (millimeters).
 - B. This drawing is subject to change without notice.
 - C. Body dimensions do not include mold flash or protrusion not to exceed 0.006 (0,15).
 - D. Falls within JEDEC MS-012 variation AA.

IMPORTANT NOTICE

Texas Instruments Incorporated and its subsidiaries (TI) reserve the right to make corrections, modifications, enhancements, improvements, and other changes to its products and services at any time and to discontinue any product or service without notice. Customers should obtain the latest relevant information before placing orders and should verify that such information is current and complete. All products are sold subject to TI's terms and conditions of sale supplied at the time of order acknowledgment.

TI warrants performance of its hardware products to the specifications applicable at the time of sale in accordance with TI's standard warranty. Testing and other quality control techniques are used to the extent TI deems necessary to support this warranty. Except where mandated by government requirements, testing of all parameters of each product is not necessarily performed.

TI assumes no liability for applications assistance or customer product design. Customers are responsible for their products and applications using TI components. To minimize the risks associated with customer products and applications, customers should provide adequate design and operating safeguards.

TI does not warrant or represent that any license, either express or implied, is granted under any TI patent right, copyright, mask work right, or other TI intellectual property right relating to any combination, machine, or process in which TI products or services are used. Information published by TI regarding third-party products or services does not constitute a license from TI to use such products or services or a warranty or endorsement thereof. Use of such information may require a license from a third party under the patents or other intellectual property of the third party, or a license from TI under the patents or other intellectual property of TI.

Reproduction of information in TI data books or data sheets is permissible only if reproduction is without alteration and is accompanied by all associated warranties, conditions, limitations, and notices. Reproduction of this information with alteration is an unfair and deceptive business practice. TI is not responsible or liable for such altered documentation.

Resale of TI products or services with statements different from or beyond the parameters stated by TI for that product or service voids all express and any implied warranties for the associated TI product or service and is an unfair and deceptive business practice. TI is not responsible or liable for any such statements.

Following are URLs where you can obtain information on other Texas Instruments products and application solutions:

Products		Applications	
Amplifiers	amplifier.ti.com	Audio	www.ti.com/audio
Data Converters	dataconverter.ti.com	Automotive	www.ti.com/automotive
DSP	dsp.ti.com	Broadband	www.ti.com/broadband
Interface	interface.ti.com	Digital Control	www.ti.com/digitalcontrol
Logic	logic.ti.com	Military	www.ti.com/military
Power Mgmt	power.ti.com	Optical Networking	www.ti.com/opticalnetwork
Microcontrollers	microcontroller.ti.com	Security	www.ti.com/security
		Telephony	www.ti.com/telephony
		Video & Imaging	www.ti.com/video
		Wireless	www.ti.com/wireless

Mailing Address: Texas Instruments
Post Office Box 655303 Dallas, Texas 75265

Copyright © 2006, Texas Instruments Incorporated